

"Apollo"®

Elkhart Products
Corporation



LASCO®
Fittings, Inc.

Retail Products Catalog
2017

"Apollo"

Conbraco Industries, Inc.
701 Matthews Mint Hill Road
Matthews, NC 28105
1-888-229-2874
www.apolloflow.com

Elkhart Products
Corporation | 

Elkhart Product Corporation
1255 Oak Street
Elkhart, IN 46514
1-888-229-2874
www.elkhartproducts.com

LASCO[®]
Fittings, Inc.

LASCO Fittings, Inc.
414 Morgan Street
P.O. Box 116
Brownsville, TN 38012
1-888-229-2874
www.lascofittings.com



Table of Contents

Who We Are.....	2
PEX Products.....	3-26
Brass Fittings.....	3-9
Poly Alloy Fittings.....	10-12
Manifolds.....	13-14
Fasteners.....	15-17
Tools.....	18-20
Pipe Cutters.....	20-21
Pipe.....	22-26
Expansion PEX Products.....	27-34
Brass Fittings.....	27-30
Poly Alloy Fittings.....	31
Manifolds.....	32
Fasteners.....	32
Tools.....	32
Pipe.....	33-34
Appliance Accessories.....	35-39
Dishwasher.....	36
Refrigerator.....	36
Washing Machine.....	37
Water Heater.....	38-39
Push Products.....	40-50
Tectite.....	40-47
Copper Push.....	48
CopperLoc.....	49-50
Press Products.....	51-53
Solder Products.....	54-65
WROT.....	54-62
Cast Brass Products.....	63-65
CPVC Fittings.....	66-69
PVC Fittings.....	70-87
Schedule 40 Fittings.....	70-81
Schedule 80 Fittings.....	82-87
Irrigation Fittings.....	88-98
Insert Fittings.....	88-91
Schedule 40 Push Fittings.....	92-93
Sprint.....	94-95
Flexi-Adapters.....	94-95
Blue Twisters.....	96-98
Warranties.....	99-101
Index.....	102-105

PEX

Appliance

Push

Press

Solder

CPVC

PVC

Irrigation

Who We Are

"Apollo"

American-made success since 1928

Conbraco Industries was created when two Detroit-based manufacturers of brass valves and fittings merged in 1928 forming Consolidated Brass Company. Over 80 years later, Conbraco is an American success story that's still being written.

The company now known as Apollo® Valves earned a reputation for developing new products to meet emerging market demands. In 1968, the company introduced its Apollo® Series 70 ball valve to the commercial market.

A revolutionary innovation at the time, the product became the most specified ball valve in the world. Line extensions have resulted in new materials, new sizes and new applications for the classic Apollo ball valve.

In 2005, the company brought all of its products under the Apollo® Valves brand. Products which had been sold under the Conbraco brand included plumbing and heating products, water gauges, pop safety and relief valves, marine fittings and backflow prevention devices. Those lines joined the company's ball valves, actuators and mixing valves as part of the complete Apollo Valves family of products.

Nearly all Apollo® Valves are produced in U.S. facilities that are second to none in the industry, including ISO-registered, state-of-the-art foundries and manufacturing facilities in Pageland and Conway, S.C. The company's headquarters is located in Matthews, N.C.

Elkhart Products
Corporation



Quality products and personnel since 1940

Elkhart Products Corporation (EPC) is located in Elkhart, Indiana – the heart of the Midwest. From its start in 1940 as a small manufacturer of screw machine products, EPC has built a reputation for quality products and quality personnel. As the company began to expand in the early 1950s and became a fabricator of various copper and aluminum tubular components, it also became known for its innovation and service.

Expansion continued with the purchase of machinery from Chase Brass and Copper Company in the late '50s and wrought copper tube fittings for the plumbing, air conditioning and refrigeration industries were added to the product line. Growth continued with the construction of plants in Fayetteville, Arkansas in 1962 and in Geneva, Indiana in 1969.

Today, EPC is part of Aalberts Industries N.V. and enjoys the distinction of being one of the world's largest manufacturers of wrought copper fittings. It's also recognized as a versatile supplier of custom fabricated tubular products to original equipment manufacturers in several industries, including automotive and air conditioning and refrigeration.

Over the last five years, EPC has branched into engineered fittings. EPC engineered push-fit fitting brands include TECTITE™ and CopperLOC™. In 2011, we introduced APOLLOXPRESS® press-fit fittings and valves. APOLLOXPRESS® products are manufactured in the USA by EPC and Apollo® Valves. Together, we bring you the most extensive line of quality American Made press-fit products.

LASCO®
Fittings, Inc.

Trouble free products for over 50 years

LASCO® Fittings manufactures Schedule 40, Schedule 80, Insert, CTS, DWV, Irrigation and Swing Joints to strict industry standards with a reputation for quality product, innovation, and technical leadership. LASCO®'s fittings are designed, produced and shipped to provide the distributor an inexpensive, consistent, trouble-free source of product for our target industries.

LASCO® Fittings is committed to sustainable stewardship as we strive to reduce our environmental footprint, conserve resources and recycle materials.

LASCO® Fittings, located in Brownsville, TN, employs experienced employees dedicated to providing the highest level of integrity, value and service. Our established management, sales and production staff ensures the LASCO® customer a superior product, at a fair price and in a timely manner. The LASCO® team is dedicated to helping you. Customers of LASCO® Fittings can rely upon a product used by millions of contractors worldwide. For over 50 years we have provided the products necessary to reliably transport liquids from source to application. Designers know the commitment LASCO® has to providing trouble free products and services.

BRASS FITTINGS

Apollo® PEX Brass Fittings are used for making junctions or directional changes with PEX pipe constructed potable water systems.

All Apollo® PEX Brass Fittings comply with the U.S. Safe Water Drinking Act (SDWA) and the 2011 U.S. Reduction of Lead in Drinking Water Act by containing equal to or less than 0.25% lead.

All Apollo® PEX Poly Alloy Fittings have barb ends unless otherwise noted. Apollo® PEX Poly Alloy Fittings can be used with Apollo® brand PEX-A and PEX-B pipe.

Specifications

Use Apollo® PEX Brass Fittings with Apollo® PEX pipe and fasten to pipe using Apollo® Crimp Rings, Sleeves, or Pinch Clamps with Apollo® PEX Tools. Follow all instructions included with Apollo® tools, fittings, and fasteners.

Approvals

- ASTM F877 and F1807 Conformance - Third Party Certified
- NSF 14 and 61
- IAPMO
- CSA B137.5

Installation

Squarely cut PEX pipe to desired length. Slide crimp ring or pinch clamp over end of pipe. Slide pipe over fitting until it touches the shoulder of the fitting. Slide the crimp ring 1/8 in.-1/4 in. from the end of the pipe and over the fitting ribs closest to the end of the fitting. Position the tool and compress completely according to tool instructions. Check crimp ring compression with a Go/No-Go Gauge.

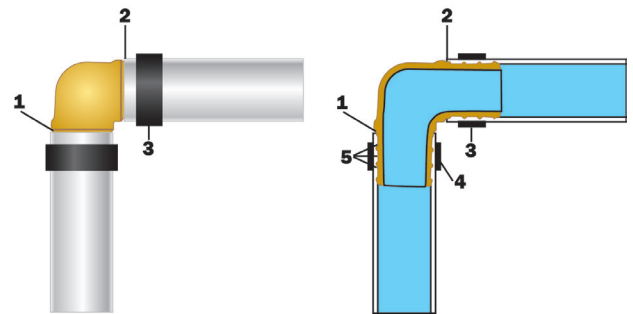
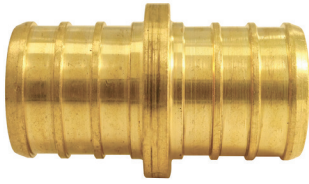
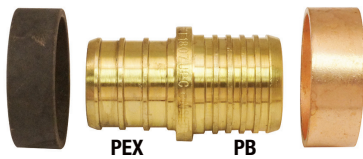

Illustration of a good connection

1. Fitting shoulder.
2. Pipe is cut squarely and stops at fitting shoulder.
3. Position the ring or clamp 1/8 in. - 1/4 in. from the end of the pipe, over the two end ribs of the fitting.
4. The ring or clamp is evenly compressed over the pipe.
5. The PEX material is uniformly compressed between the ribs, resulting in a leak-free joint.



Part Number	Description	Carton Qty	UPC
COUPLINGS			
APXC3838	3/8 in.	12	670750701740
APXC1238	1/2 in. X 3/8 in.	12	670750701092
APXC1212	1/2 in.	12	670750700927
APXC121210PK	1/2 in. (10 Pack)	6	670750700989
APXC1250PK	1/2 in. (50 Pack)	5	670750881275
APXC1234	3/4 in. X 1/2 in.	12	670750701085
APXC3434	3/4 in.	12	670750701108
APXC3410PK	3/4 in. (10 Pack)	6	670750948442
APXC3450PK	3/4 in. (50 Pack)	5	670750881282
APXC341	1 in. X 3/4 in.	6	670750779473
APXC11	1 in.	6	670750700804



PEX x POLYBUTYLENE COUPLINGS			
APXBC1212	1/2 in. PEX x PB	6	670750700514
APXBC12125PK	1/2 in. PEX x 1/2 in. PB (5 Pack)	10	670750779770
APXBC3434	3/4 in. PEX x 3/4 in. PB	6	670750700767

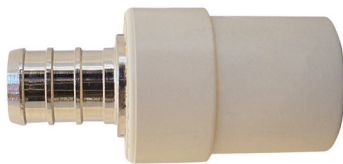

PEX x CPVC COUPLINGS			
APXCPVC12	1/2 in. PEX x CPVC	10	670750570773
APXCPVC34	3/4 in. PEX x CPVC	10	670750570780



ELBOWS			
APXE12	1/2 in.	24	670750702587
APXE121210PK	1/2 in. (10 Pack)	6	670750702624
APXE1250PK	1/2 in. (50 Pack)	5	670750881312
APXE1234	3/4 in. X 1/2 in.	6	670750702723
APXE3434	3/4 in.	24	670750702778
APXE3410PK	3/4 in. (10 Pack)	6	670750948565
APXE3450PK	3/4 in. (50 Pack)	5	670750881329
APXE11	1 in.	6	670750702570

Part Number	Description	Carton Qty	UPC
DROP EAR ELBOWS			
APXDEE12	1/2 in. PEX x 1/2 in. FPT	12	670750702549
APXDEE3412	3/4 in. PEX x 1/2 in. FPT	10	670750570766
APXDEE34	3/4 in. PEX x 3/4 in. FPT	10	670750272325

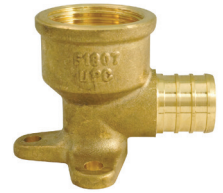

FEMALE ELBOW			
APXFAE1212	1/2 in. X 1/2 in. FPT Swivel	6	670750703034

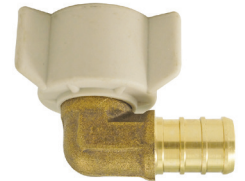

MALE ELBOWS			
APXME12	1/2 in. PEX x 1/2 in. MPT	6	670750272882
APXME1234	1/2 in. PEX x 3/4 in. MPT	10	670750439506
APXME34	3/4 in. PEX x 3/4 in. MPT	10	670750272899

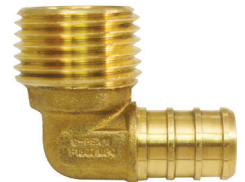

FEMALE ADAPTERS – THREADED			
APXFA1212	1/2 in. PEX x 1/2 in. FPT	24	670750702976
APXFB1212S	1/2 in. PEX x 1/2 in. FPT Swivel - Plastic Nut	12	670750703072
APXFA12125PK	1/2 in. PEX x 1/2 in. FPT (5 Pack)	6	670750702990
APXFA1234	1/2 in. PEX x 3/4 in. FPT	10	670750272011
APXFA3412	3/4 in. PEX x 1/2 in. FPT	10	670750272028
APXFA3434	3/4 in. PEX x 3/4 in. FPT	12	670750703027
APXFF3434S	3/4 in. PEX x 3/4 in. FPT Swivel - Loose, Brass Nut	6	670750779817
APXFA34B1F	3/4 in. PEX x 1 in. FPT	5	670750779787
APXFA11	1 in. PEX x 1 in. FPT	6	670750702846

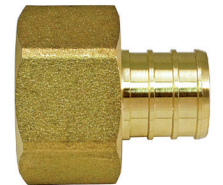

FEMALE ADAPTERS – SOLDER			
APXFS1212	1/2 in. PEX x 1/2 in. FS	24	670750703324
APXFS3434	3/4 in. PEX x 3/4 in. FS	12	670750703386
APXFSA11	1 in. PEX x 1 in. FS	5	670750703485



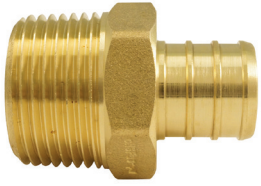

Part Number	Description	Carton Qty	UPC
MALE ADAPTERS – THREADED			
APXMA3812	3/8 in. PEX x 1/2 in. MPT	6	670750949227
APXMA1212	1/2 in. PEX x 1/2 in. MPT	24	670750703669
APXMA125PK	1/2 in. PEX x 1/2 in. MPT (5 Pack)	6	670750948916
APXMA1250PK	1/2 in. PEX x 1/2 in. MPT (50 Pack)	5	670750881336
APXMA1234	1/2 in. MPT x 3/4 in. PEX	12	670750704062
APXMA3412	3/4 in. MPT x 1/2 in. PEX	12	670750704314
APXMA3434	3/4 in. PEX x 3/4 in. MPT	12	670750704383
APXMA34345PK	3/4 in. PEX x 3/4 in. MPT (5 Pack)	5	670750704628
APXMA3450PK	3/4 in. PEX x 3/4 in. MPT (50 Pack)	5	670750881343
APXMA341	3/4 in. PEX x 1 in. MPT	5	670750779824
APXMA134	1 in. PEX x 3/4 in. MPT	6	670750272004
APXMA11	1 in. PEX x 1 in. MPT	6	670750703607



MALE ADAPTERS – SOLDER			
APXMS1212	1/2 in. PEX x 1/2 in. MS	12	670750704758
APXMS121210PK	1/2 in. PEX x 1/2 in. MS (10 Pack)	6	670750704765
APXMS3434	3/4 in. PEX x 3/4 in. MS	12	670750704789
APXMSA11	1 in. PEX x 1 in. MS	5	670750779831

Part Number	Description	Carton Qty	UPC
TEES			
APXT38	3/8 in. PEX	12	670750698279
APXT12	1/2 in. PEX	24	670750706295
APXT1210PK	1/2 in. PEX (10 Pack)	6	670750706301
APXT1250PK	1/2 in. PEX (50 Pack)	5	670750881299
APXT121234	1/2 in. x 1/2 in. x 3/4 in. PEX	12	670750779848
APXT34	3/4 in. PEX	12	670750706325
APXT3410PK	3/4 in. PEX (10 Pack)	6	670750949265
APXT3450PK	3/4 in. PEX (50 Pack)	5	670750881305
APXT341212	3/4 in. x 1/2 in. x 1/2 in. PEX	12	670750706370
APXT341234	3/4 in. x 1/2 in. x 3/4 in. PEX	12	670750706530
APXT343412	3/4 in. x 3/4 in. x 1/2 in. PEX	24	670750698019
APXT3434125PK	3/4 in. x 3/4 in. x 1/2 in. PEX (5 Pack)	5	670750698026
APXT11	1 in. PEX	6	670750705991
APXT1112	1 in. x 1 in. x 1/2 in. PEX	6	670750706165
APXT1134	1 in. x 1 in. x 3/4 in. PEX	6	670750706264

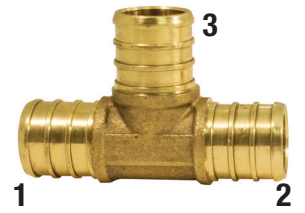

TEST PLUGS			
APXP12	1/2 in. PEX	12	670750704796
APXP125PK	1/2 in. PEX (5 Pack)	6	670750949258
APXP1250PK	1/2 in. PEX (50 Pack)	5	670750881350
APXP34	3/4 in. PEX	12	670750704826
APXP3450PK	3/4 in. PEX (50 Pack)	5	670750881367

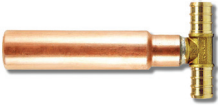
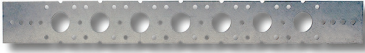

Part Number	Description	Carton Qty	UPC
MISCELLANEOUS			
 APPW14RISER	PEX Riser 1/4 in. (3/8 in. OD) x 20 in.	60	670750954474
 APXCSST18	CSST Water Heater Connector 1/2 in. PEX x 3/4 in. FHT x 18 in.	5	670750570551
 APXHAMTEE	Hammer Arrestor Tee 1/2 in. PEX	6	670750946769
 APXSOBAR	PEX Stub-Out Bend Support Bar 1/2 in. PEX x 18 in.	25	670750947940
 APXSTP	Shower Test Plug 1/2 in. NPT	10	670750469466
 APXSTUB6	Copper Stubout 1/2 in. PEX x 6 in.	6	670750948039
 APXSTUB8	Copper Stubout 1/2 in. PEX x 8 in.	12	670750705939
 APXSTUB8WE	Copper Stubout with Ear 1/2 in. PEX x 8 in.	12	670750352485

Part Number	Description	Carton Qty	UPC
VALVES			
APXPV1238A	Chrome Angle Push Valve 1/2 in. Push x 3/8 in. C	12	670750705854
APXPV1238S	Chrome Straight Push Valve 1/2 in. Push x 3/8 in. C	12	670750706523
APXGHV1234	Garden Hose Valve 1/2 in. PEX x 3/4 in. MH	6	670750439902
APXFF1212S	Brass Female Swivel Valve 1/2 in. PEX x 1/2 in. FPT	5	670750703102
APXMV34S	Thermostatic Master Mixing Valve 3/4 in. PEX	2	670750039409
APXV1212	Brass Ball Valve 1/2 in. PEX	12	670750698415
APXV3434	Brass Ball Valve 3/4 in. PEX	12	670750698781
APXV11	Brass Ball Valve 1 in. PEX	6	670750226878
APXVA1238C	Chrome Angle Stop Valve 1/2 in. PEX x 3/8 in. C	24	670750698811
APXVS1238C	Chrome Straight Stop Valve 1/2 in. PEX x 3/8 in. C	24	670750698835

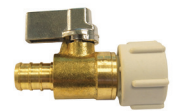

POLY ALLOY FITTINGS



Apollo® PEX Poly Alloy Fittings are used for making junctions or directional changes with PEX pipe constructed potable water systems. These fittings are made from Polyphenylsulfone materials. Poly Alloy fittings are great for plumbing systems in contact with hard water.

All Apollo® PEX Poly Alloy Fittings have barb ends unless otherwise noted. Apollo® PEX Poly Alloy Fittings can be used with Apollo® brand PEX-A and PEX-B pipe.

Specifications

Use Apollo® PEX Poly Alloy Fittings with Apollo® PEX pipe and fasten to pipe using Apollo® Crimp Rings, Sleeves, or Pinch Clamps with Apollo® PEX Tools. Follow all instructions included with Apollo® tools, fittings, and fasteners.

Approvals

- ASTM F877 and F2159 Conformance - Third Party Certified
- cNSF®us pw-G
- IAPMO
- CSA B137.5

Installation

Squarely cut PEX pipe to desired length. Slide crimp ring or pinch clamp over end of pipe. Slide pipe over fitting until it touches the shoulder of the fitting. Slide the crimp ring 1/8 in.-1/4 in. from the end of the pipe and over the fitting ribs closest to the end of the fitting. Position the tool and compress completely according to tool instructions. Check crimp ring compression with a Go/No-Go Gauge.

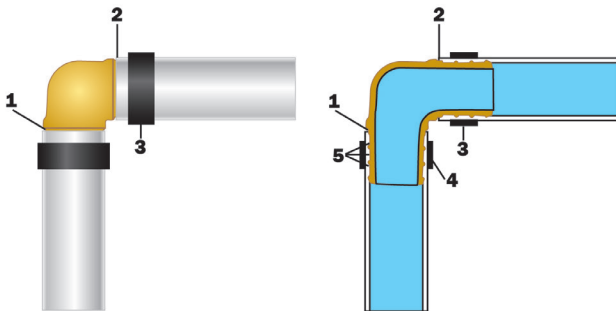

Illustration of a good connection

1. Fitting shoulder.
2. Pipe is cut squarely and stops at fitting shoulder.
3. Position the ring or clamp 1/8 in. - 1/4 in. from the end of the pipe, over the two end ribs of the fitting.
4. The ring or clamp is evenly compressed over the pipe.
5. The PEX material is uniformly compressed between the ribs, resulting in a leak-free joint.

Part Number	Description	Carton Qty	UPC
COUPLINGS			
PXPAC125PK	1/2 in. PEX (5 Pack)	6	670750950445
APXPAC1250PK	1/2 in. PEX (50 Pack)	5	670750881503
PXPAC345PK	3/4 in. PEX (5 Pack)	6	670750950599
APXPAC3450PK	3/4 in. PEX (50 Pack)	5	670750881763
PXPAC34125PK	3/4 in. PEX x 1/2 in. PEX (5 Pack)	6	670750950469
PXPAC3415PK	3/4 in. PEX x 1 in. PEX (5 Pack)	6	670750950537
PXPAC115PK	1 in. PEX (5 Pack)	6	670750950391



ELBOWS			
PXPAE125PK	1/2 in. PEX (5 Pack)	6	670750950742
APXPAE1250PK	1/2 in. PEX (50 Pack)	5	670750695988
PXPAE12345PK	1/2 in. PEX x 3/4 in. PEX (5 Pack)	6	670750950711
PXPAE345PK	3/4 in. PEX (5 Pack)	6	670750950773
APXPAE3450PK	3/4 in. PEX (50 Pack)	5	670750882104
PXPAE115PK	1 in. PEX (5 Pack)	6	670750950650
PXPAFES125PK	1/2 in. PEX x 1/2 in. FPT (5 Pack)	6	670750950841
PXPAME125PK	1/2 in. PEX x 1/2 in. MPT (5 Pack)	6	670750951015



FEMALE ADAPTERS			
PXPAF1212S5PK	1/2 in. PEX x 1/2 in. FPT (5 Pack)	6	670750950780





Part Number	Description	Carton Qty	UPC
MALE ADAPTERS			
PXPAM125PK	1/2 in. PEX x 1/2 in. MPT (5 Pack)	6	670750950919
PXPAM345PK	3/4 in. PEX x 3/4 in. MPT (5 Pack)	6	670750984907
PXPAM34125PK	3/4 in. PEX x 1/2 in. MPT (6 Pack)	6	670750950964



TEST PLUGS			
PXPAP125PK	1/2 in. PEX (5 Pack)	6	670750951022
APXPAP1250PK	1/2 in. PEX (50 Pack)	5	670750882111
PXPAP345PK	3/4 in. PEX (5 Pack)	6	670750951084
APXPAP3450PK	3/4 in. PEX (50 Pack)	5	670750882135



TEES			
PXPAT125PK	1/2 in. PEX (2 Pack)	6	670750951794
APXPAT1250PK	1/2 in. PEX (50 Pack)	5	670750695711
PXPAT1212345PK	1/2 in. PEX x 1/2 in. PEX x 3/4 in. PEX (2 Pack)	6	670750951770
PXPAT345PK	3/4 in. PEX (2 Pack)	6	670750953958
APXPAT3450PK	3/4 in. PEX (50 Pack)	5	670750882098
PXPAT3412125PK	3/4 in. PEX x 1/2 in. PEX x 1/2 in. PEX (2 Pack)	6	670750953057
PXPAT3412345PK	3/4 in. PEX x 1/2 in. PEX x 3/4 in. PEX (2 Pack)	6	670750953842
PXPA3434125PK	3/4 in. PEX x 3/4 in. PEX x 1/2 in. PEX (2 Pack)	6	670750953934

MANIFOLDS

Apollo PEX Manifold Systems are available in a wide range of outlet ports. Some include the appropriate number of valves for each outlet.

Specifications

- Save Time and Money - Manifolds allow you to make longer continuous runs of PEX pipe, meaning you buy fewer fittings and spend less time installing.
- Fewer Possible Leaks - Longer continuous runs with fewer crimp connections means fewer chances of leaks and avoiding the possibility of thousands of dollars in water damage.
- Controls Scalding - When plumbed so that each branch line feeds only one fixture, the manifold greatly reduces pressure fluctuations and temperature swings that cause scalding.
- Quiet Plumbing - Longer runs of pipe using fewer fittings means smoother bends and turns which reduces line noise and water hammer.

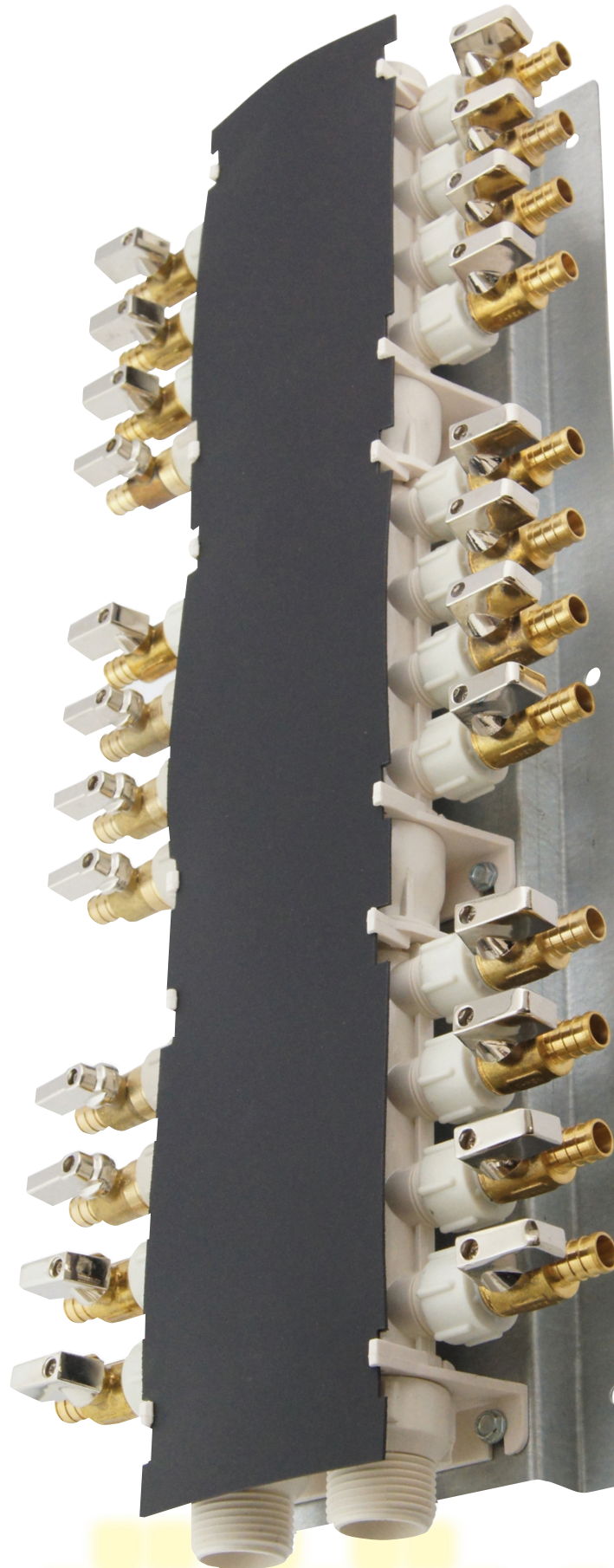
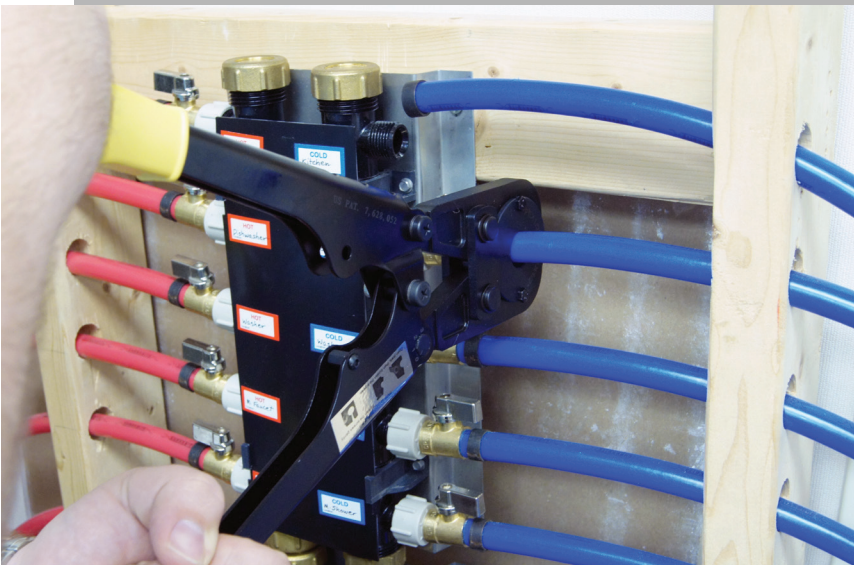



Part Number	Description	Carton Qty	UPC
MANIFOLD SYSTEMS			
6907912CP	12 Port	1	670750582615
6907984CP	16 Port	1	670750382680
6907920CP	20 Port	1	670750582622
6907924CP	24 Port	1	670750582639
6907928CP	28 Port	1	670750582646
6907932CP	32 Port	1	670750582653
6907936CP	36 Port	1	670750582738

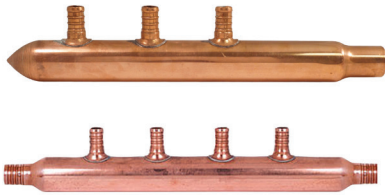

COPPER MANIFOLDS			
PXCM3PT	3 Port, Closed End	5	670750384424
APXCM4PT0	4 Port, Open End	6	670750439483
APXCM6PT0	6 Port, Open End	6	670750439490

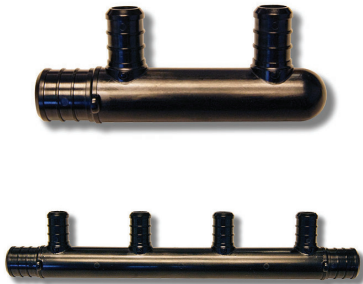

POLY ALLOY MANIFOLDS			
PXPA2PTC	2 Port, Closed End	20	670750022548
PXPA4PTC	4 Port, Closed End	10	670750022685
PXPA2PT0	2 Port, Open End	20	670750022654
PXPA4PT0	4 Port, Open End	10	670750022746
PXPA6PT0	6 Port, Open End	10	670750038808

MANIFOLD ACCESSORIES

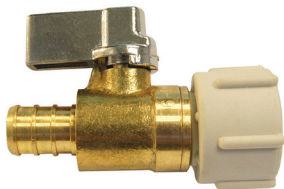

APXFF1212S	Brass Female Swivel Valve 1/2 in. PEX x 1/2 in. FPT (Manifold Replacement Valve)	5	670750703102
------------	--	---	--------------



APXFA34B1F	Female Adapter 3/4 in. PEX x 1 in. FPT (Manifold Inlet Adapter)	5	670750779787
------------	---	---	--------------

PEX FASTENERS

Crimp Rings

Apollo Crimp Rings are made from copper materials and can be used with brass or poly alloy PEX fittings. A gauge is provided with Apollo PEX Crimp Tools that can be used to check crimp rings for a proper crimp. Pro crimp rings have a plastic top attached to allow for hands-free fastening and guarantees proper placement of the crimp ring.

Pinch Clamps

Apollo Stainless Steel Pinch Clamps can be used with brass or poly alloy PEX fittings. One Pinch Clamp Tool can clamp several sizes of pinch clamps.

Sleeves

Apollo Stainless Steel Sleeves are made from corrosion proof 304 stainless steel and designed with a pipe depth indicator to ensure a secure connection. They are double crimped once installed for the strongest, most reliable fastening method available, as well as, offering a neat, clean appearance.

Pipe Hangers

Plastic hangers are recommended for use with Apollo PEX tubing. To prevent noise transfer, only use hangers that keep the tube off of the nailing surface. Hangers should be used every 32 in. on horizontal runs and every 4 ft. on vertical runs. Allow the tube to dip between hangers and never over tighten. To prevent stress on the crimp joints, always support tubing before and after the fitting.

Pipe Bends

Do not bend tube too tightly. The minimum recommended bend radius is six times the tube size (i.e. ½ in. tube = 3 in. bend radius). When making a 90° turn, use bend supports.





Part Number	Description	Carton Qty	UPC
CRIMP RINGS			
APXCR3810PK	3/8 in. (10 Pack)	5	670750702402
APXCR1210PK	1/2 in. (10 Pack)	30	670750701931
APXCR1225PK	1/2 in. (25 Pack)	24	670750955563
APXCR1250PK	1/2 in. (50 Pack)	10	670750701948
APXCR12100PK	1/2 in. (100 Pack)	1	670750695360
APXCR3410PK	3/4 in. (10 Pack)	15	670750702303
APXCR3425PK	3/4 in. (25 Pack)	12	670750702334
APXCR34100PK	3/4 in. (100 Pack)	1	670750695438
APXCR15PK	1 in. (5 Pack)	5	670750702198
APXCR125PK	1 in. (25 Pack)	6	670750949272



PRO CRIMP RINGS			
APXCR12LT	1/2 in. (10 Pack)	5	670750779886
APXCR34LT	3/4 in. (10 Pack)	5	670750779893



PINCH CLAMPS			
PXPC3810PK	3/8 in. (10 Pack)	10	670750269127
PXPC1210PK	1/2 in. (10 Pack)	20	670750269134
PXPC1225PK	1/2 in. (25 Pack)	10	670750271458
PXPC12100PK	1/2 in. (100 Pack)	1	670750949630
PXPC12100JR	1/2 in. (100 Pcs in Jar)	4	670750039638
PXPC3410PK	3/4 in. (10 Pack)	15	670750269158
PXPC3425PK	3/4 in. (25 Pack)	10	670750271465
PXPC34100PK	3/4 in. (100 Pack)	1	670750950049
PXPC34100JR	3/4 in. (100 Pcs in Jar)	2	670750039676
PXPC15PK	1 in. (5 Pack)	10	670750269165
PXPC110PK	1 in. (10 Pack)	6	670750949562



SLEEVES			
PXSS1210PK	1/2 in. (10 Pack)	10	670750412875
PXSS1225PK	1/2 in. (25 Pack)	10	670750412899
PXSS3410PK	3/4 in. (10 Pack)	10	670750412905
PXSS3425PK	3/4 in. (25 Pack)	10	670750412912

Part Number	Description	Carton Qty	UPC
J-HOOKS			
APXJH1210PK	1/2 in. (10 Pack)	12	670750947049
APXJH3410PK	3/4 in. (10 Pack)	12	670750947308

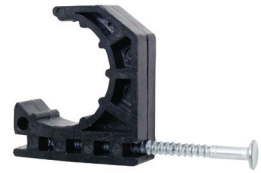

PIPE BENDS			
APXMBEND12	1/2 in. PEX - Metal	12	670750947346
APXMBEND34	3/4 in. PEX - Metal	12	670750947766
PXBEND12	1/2 in. PEX - Plastic	12	670750437380
PXBEND34	3/4 in. PEX - Plastic	10	670750437397
APXSOBEND2PK	PEX Stub-Out Bend for Support Bar (2-Pack)	6	670750947971



PIPE BENDS			
APXSUSCLAMP	1/2 in. CTS Suspension Clamp (10 Pack)	6	670750948077
APXSUSCLAMP34	3/4 in. CTS Suspension Clamp (10 Pack)	6	670750948275



PEX TOOLS

Cut, crimp, sleeve, clamp, gauge, - Apollo offers a wide variety of PEX Tools. Apollo PEX Tools are manufactured from high quality carbon steel and come with a two year warranty.

Types

- Crimp Tools
- Clamp Tools
- Sleeve Tool
- Removal Tools
- Gauge
- Pipe Cutters



Part Number	Description	Carton Qty	UPC
FASTENING TOOLS			

69PTKH0015K	PEX Multi-Head Crimp Tool Kit 3/8 in. - 1 in.	2	670750193088
-------------	--	---	--------------



69PTKH0014C	1/2 in. & 3/4 in. PEX Combo Crimp Tool	2	670750338908
-------------	--	---	--------------

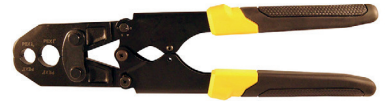

69PTKH00143	1/2 in. PEX Crimp Tool	3	670750193118
-------------	------------------------	---	--------------

69PTKH00144	3/4 in. PEX Crimp Tool	3	670750193125
-------------	------------------------	---	--------------



69PTKANG143	1/2 in. PEX Angle Crimp Tool	1	670750337512
-------------	------------------------------	---	--------------



69PTKH0014SS	PEX Combo Sleeve Tool Works with 1/2 in. and 3/4 in. Stainless Steel Sleeves	3	670750412936
--------------	--	---	--------------











69PTKG1096	PEX Pinch Clamp Fastening Tool - Fastens 3/8 in.-1 in. Pinch Clamps	3	670750193095
------------	---	---	--------------



69PTBJ0010C	One Hand PEX Pinch Clamp Fastening Tool - Fastens 3/8 in.-1 in. Pinch Clamps, LED light confirms complete fasten	1	670750193101
-------------	---	---	--------------



Part Number	Description	Carton Qty	UPC
MISCELLANEOUS			
	69PFT PressFast Tool Fastens 1/2 in.-1 in. Copper Press and PEX Crimp Fittings	1	670750096693
	69PTKD0009 PEX Ring Removal Tool Removes rings up to 1 in.	6	670750193149
	69PTKPCRR PEX Pinch Clamp Removal Tool Removes 3/8 in - 1 in. clamps	5	670750570605
PEX PIPE CUTTERS			
	69PTKC001 Plastic Pipe and Tubing Cutter Cuts 1/8 in. - 1½ in.	6	670750292736
	69PC02PZ Ratcheting Pipe Cutter Cuts up to 1¼ in. PVC, CPVC, and other plastic pipe	12	670750095207
	69PC01RB Replacement Blade for 69PC02PZ	10	670750432774
	69PC03PZ Clamp Tension Pipe Cutter Cuts up to 3/4 in. Copper or Plastic Pipe	12	670750095214
	PLTL82 1/2 in. Quik Cut For use with Copper, PEX, CPVC Pipe	10	670750480058
	PLTL83 3/4 in. Quik Cut For use with Copper, PEX, CPVC Pipe	10	670750480157
	PLTL60 Replacement Cutter Wheels for PLTL82 & PLTL83 (2 Pack)	50	670750480225

Part Number	Description	Carton Qty	UPC
PIPE CUTTERS			
69PC06PZ	PVC Pipe Cutter - Cuts up to 2 in. PVC, CPVC, PE, PEX	5	670750594670
69PC06PZRB	Replacement blade for 69PC06PZ	10	670750598425
69PC07PZ	CSST Tubing Cutter Cuts thin walled stainless steel or copper tubing 1/4 in. - 1 1/4 in. O.D.	5	670750361647
PROTC118	ProFit 1 1/8 in. Tubing Cutter Cuts 1/8 in. - 1 1/8 in. copper, stainless steel, aluminum, PVC	10	670750678172
PROTC2	ProFit 2 in. Tubing Cutter Cuts 1/2 in. - 2 in. copper, stainless steel, aluminum, PVC	5	670750678189



PEX PIPE

PEX tubing is cross-linked, high-density polyethylene. It's available in white, red, or blue colors for easy identification of hot and cold water lines. The Apollo® PEX tubing listed in the following pages is type PEX-B (PE-Xb, PEXb).

PEX tubing is for use in hot and cold potable water distribution systems as well as hydronic radiant heating systems. PEX tubing can also be used in continuously recirculating plumbing systems up to 140° F while maintaining chlorine resistance.

Features

- Tough
- Flexible
- Less expensive than other plumbing materials
- Copper tube size dimensions (CTS)
- Available in white, red, or blue

Standards / Certifications

- PEX 5006 - SDR 9
- Meets ASTM F876/F877
- cNSFus-pw/rfh
- ANSI/NSF Standards 61 & 14
- cUPC
- CSA B137.5

Pressure & Temperature

- 160 psi @ 73° F, 100 psi @ 180° F

Installation

To cut PEX tubing, use a PEX tubing cutter and cut at a 90° angle. Clear the cut end of any burrs or debris. PEX tubing can be run through holes drilled into the center of studs or by using straps and hangers. Bend supports can be used to make bends and angles instead of having to cut the tubing and use fittings. A variety of barb fittings or push type fittings can be used with PEX tubing. ***Do not expose PEX tubing to direct sunlight.***

It is recommended to insulate hot water lines with standard foam polyethylene pipe insulation to prevent heat loss. If installing in an area that experiences harsh winters, it's recommended to insulate both hot and cold water lines to prevent freezing.

Part Number	Description	Carton Qty	UPC
BLUE PEX PIPE			
APPB212	1/2 in. x 2 ft. Stick	60	670750954078
APPB512	1/2 in. x 5 ft. Stick	10	670750954221
APPB1210	1/2 in. x 10 ft. Stick	10	670750809309
APPB2012	1/2 in. x 20 ft. Stick	10	670750754531
APPB10012	1/2 in. x 100 ft. Coil	1	670750697746
APPB30012	1/2 in. x 300 ft. Coil	1	670750698842
APPB50012	1/2 in. x 500 ft. Coil	1	670750754302
APPB234	3/4 in. x 2 ft. Stick	30	670750954122
APPB534	3/4 in. x 5 ft. Stick	10	670750954238
APPB3410	3/4 in. x 10 ft. Stick	10	670750615528
APPB2034	3/4 in. x 20 ft. Stick	10	670750754555
APPB10034	3/4 in. x 100 ft. Coil	1	670750697920
APPB30034	3/4 in. x 300 ft. Coil	1	670750754289
APPB50034	3/4 in. x 500 ft. Coil	1	670750754319
APPB101	1 in. x 10 ft. Stick	5	670750954061
APPB1001	1 in. x 100 ft. Coil	1	670750990403

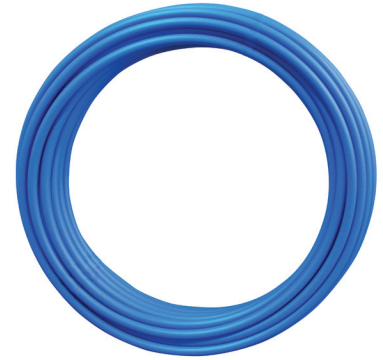

RED PEX PIPE			
APPR212	1/2 in. x 2 ft. Stick	60	670750954290
APPR512	1/2 in. x 5 ft. Stick	10	670750954344
APPR1210	1/2 in. x 10 ft. Stick	10	670750615498
APPR2012	1/2 in. x 20 ft. Stick	10	670750754579
APPR10012	1/2 in. x 100 ft. Coil	1	670750698859
APPR30012	1/2 in. x 300 ft. Coil	1	670750706455
APPR50012	1/2 in. x 500 ft. Coil	1	670750754357
APPR234	3/4 in. x 2 ft. Stick	30	670750954320
APPR534	3/4 in. x 5 ft. Stick	10	670750954368
APPR3410	3/4 in. x 10 ft. Stick	10	670750809606
APPR2034	3/4 in. x 20 ft. Stick	10	670750754593
APPR10034	3/4 in. x 100 ft. Coil	1	670750698927
APPR30034	3/4 in. x 300 ft. Coil	1	670750754333
APPR50034	3/4 in. x 500 ft. Coil	1	670750754371
APPR1001	1 in. x 100 ft. Coil	1	670750990397





Part Number	Description	Carton Qty	UPC
WHITE PEX PIPE			
APPW514	1/4 in. x 5 ft. Stick	10	670750754456
APPW538	3/8 in. x 5 ft. Stick	10	670750700231
APPW1038	3/8 in. x 10 ft. Stick	10	670750954467
APPW212	1/2 in. x 2 ft. Stick	60	670750747366
APPW512	1/2 in. x 5 ft. Stick	10	670750754470
APPW1012	1/2 in. x 10 ft. Stick	10	670750699665
APPW2012	1/2 in. x 20 ft. Stick	10	670750754494
APPW2512	1/2 in. x 25 ft. Coil	1	670750771675
APPW5012	1/2 in. x 50 ft. Coil	1	670750771712
APPW10012	1/2 in. x 100 ft. Coil	1	670750699306
APPW30012	1/2 in. x 300 ft. Coil	1	670750699979
APPW50012	1/2 in. x 500 ft. Coil	1	670750754401
APPW234	3/4 in. x 2 ft. Stick	30	670750747373
APPW534	3/4 in. x 5 ft. Stick	10	670750700132
APPW1034	3/4 in. x 10 ft. Stick	10	670750699894
APPW2034	3/4 in. x 20 ft. Stick	10	670750754517
APPW2534	3/4 in. x 25 ft. Coil	1	670750771699
APPW5034	3/4 in. x 50 ft. Coil	1	670750954498
APPW10034	3/4 in. x 100 ft. Coil	1	670750699481
APPW30034	3/4 in. x 300 ft. Coil	1	670750754388
APPW50034	3/4 in. x 500 ft. Coil	1	670750754418
APPW51	1 in. x 5 ft. Stick	5	670750770418
APPW101	1 in. x 10 ft. Stick	5	670750699634
APPW201	1 in. x 20 ft. Stick	5	670750571190
APPW1001	1 in. x 100 ft. Coil	1	670750699221
APPW3001	1 in. x 300 ft. Coil	1	670750443084

OXYGEN BARRIER PEX PIPE

Oxygen Barrier PEX pipe has been designed to prevent diffusion of oxygen into hydronic radiant heating systems. A layer of polymer is laminated to the outside surface which is highly resistant to the passage of oxygen. Oxygen Barrier PEX pipe is good for hydronic radiant heating, cooling, and snow melting systems using water or water/glycol mix. It may be installed in concrete, gypsum-based lightweight concrete, sand, asphalt, in or under wood flooring, or behind wallboard or plaster. Oxygen Barrier PEX pipe may also be used as transfer lines for baseboard heating systems with a maximum operating temperature of 200° F @ 100 psi.

Features

- Tough
- Flexible
- Copper tube size dimensions (CTS)

Approvals

- ANSI/NSF Standards 61 & 14
- ASTM F876 and F877
- ASTM D2765
- DIN 4726
- ICBO ER #5287

Pressure & Temperature

- 160 psi @ 73° F, 100 psi @ 180° F

Installation

To cut PEX pipe use a PEX pipe cutter and cut at a 90° angle. Clear the cut end of any burrs or debris. Oxygen Barrier PEX pipe can also be installed in concrete, gypsum-based lightweight concrete, sand, asphalt, in or under wood flooring, or behind wallboard or plaster. Bend supports can be used to make bends and angles instead of having to cut the tubing and use fittings. A variety of barb fittings or push type fittings can be used with PEX pipe.





Part Number	Description	Carton Qty	UPC
OXYGEN BARRIER PEX PIPE			
APPOB10038	3/8 in. x 100 ft. Coil	1	670750954511
APPOB30038	3/8 in. x 300 ft. Coil	1	670750954788
APPOB10012	1/2 in. x 100 ft. Coil	1	670750954504
APPOB30012	1/2 in. x 300 ft. Coil	1	670750754241
APPOB50012	1/2 in. x 500 ft. Coil	1	670750519826
APPOB100012	1/2 in. x 1000 ft. Coil	1	670750519833
APPOB1034	3/4 in. x 10 ft. Stick	10	670750954566
APPOB10034	3/4 in. x 100 ft. Coil	1	670750754258
APPOB30034	3/4 in. x 300 ft. Coil	1	670750754272
APPOB50034	3/4 in. x 500 ft. Coil	1	670750519840

EXPANSION PEX BRASS FITTINGS

Apollo® Expansion PEX Brass Fittings are used for making junctions or directional changes with PEX-A pipe constructed potable water systems.

All Apollo® Expansion PEX Brass Fittings comply with the U.S. Safe Water Drinking Act (SDWA) and the 2011 U.S. Reduction of Lead in Drinking Water Act by containing equal to or less than 0.25% lead.

All Apollo® Expansion PEX Fittings have barb ends unless otherwise noted. Apollo® Expansion PEX brass fittings are compatible with Apollo® PEX-A pipe and Uponor (Wirsbo) ProPEX™. (ProPEX™ is a trademark of Uponor [Wirsbo].)

Specifications

Use Apollo® Expansion PEX Brass Fittings with Apollo® PEX-A pipe and fasten to pipe using Apollo® Expansion Sleeves with Apollo® Expansion PEX Tools. Follow all instructions included with Apollo® tools, fittings, and fasteners.

Approvals

- ASTM F877 and F1807 Conformance - Third Party Certified
- NSF 14 and 61
- IAPMO
- CSA B137.5

Installation

Cut pipe squarely and place expansion sleeve on end. Insert tool head into tubing and expand (Refer to tool instructions for recommended number of expansions per tubing size). Immediately remove tool and insert fitting into pipe to shoulder. Pipe may take up to two minutes to fully seal fitting.



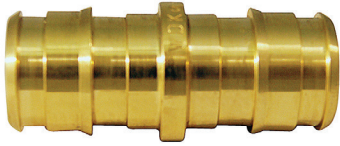

Part Number	Description	Carton Qty	UPC
BRASS COUPLINGS			
EPXC1210PK	1/2 in. (10 Pack)	5	670750839399
EPXC12345PK	3/4 in. x 1/2 in. (5 Pack)	5	670750839436
EPXC3410PK	3/4 in. (10 Pack)	5	670750839405
EPXC341	1 in. x 3/4 in.	5	670750839467
EPXC11	1 in.	5	670750839450

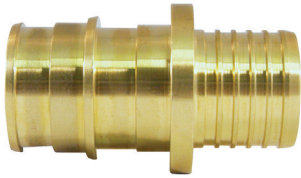

BRASS TRANSITIONAL COUPLINGS			
EPXBC125PK	1/2 in. PEX x POLY B (5 Pack)	5	670750839474
EPXBC345PK	3/4 in. PEX x POLY B (5 Pack)	5	670750839498



BRASS ELBOWS			
EPXE1210PK	1/2 in. (10 Pack)	5	670750840302
EPXFE12S	1/2 in. PEX x FPT Swivel	5	670750842115
EPXME125PK	1/2 in. PEX x MPT (5 Pack)	5	670750840371
EPXE1234	1/2 in. x 3/4 in.	5	670750842030
EPXE3410PK	3/4 in. (10 Pack)	5	670750849152
EPXE11	1 in.	5	670750840340



BRASS DROP EAR ELBOWS			
EPXDDEE12	1/2 in. PEX x FPT	5	670750840265
EPXDDEE3412	3/4 in. PEX x 1/2 in. FPT	5	670750842559
EPXDDEE34	3/4 in. PEX x FPT	5	670750840203

Part Number	Description	Carton Qty	UPC
BRASS FEMALE ADAPTERS			
EPXFA1210PK	1/2 in. PEX x FPT (10 Pack)	5	670750840395
EPXFA12S	1/2 in. PEX x FPT SWIVEL	5	670750842412
EPXFS1210PK	1/2 in. PEX x FS (10 Pack)	5	670750840289
EPXFA12345PK	1/2 in. PEX x 3/4 in. FPT (5 Pack)	5	670750840555
EPXFS1234	1/2 in. PEX x 3/4 in. FS	5	670750840296
EPXFA34125PK	3/4 in. PEX x 1/2 in. FPT (5 Pack)	5	670750840425
EPXFA3410PK	3/4 in. PEX x FPT (10 Pack)	5	670750840500
EPXFA34S	3/4 in. PEX x FPT SWIVEL	5	670750842443
EPXFS345PK	3/4 in. PEX x FS (5 Pack)	5	670750840319
EPXFA341	3/4 in. PEX x 1 in. FPT	5	670750840807
EPXFS341	3/4 in. PEX x 1 in. FS	5	670750840333
EPXFA1	1 in. PEX x FPT	5	670750840579
EPXFSA11	1 in. PEX x FS	5	670750840357

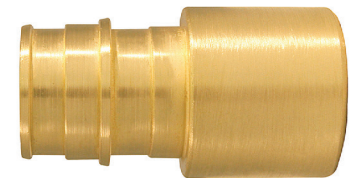
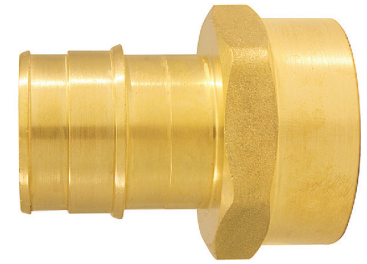

BRASS MALE ADAPTERS			
EPXMA1210PK	1/2 in. PEX x MPT (10 Pack)	5	670750841057
EPXMS1210PK	1/2 in. PEX x MS (10 Pack)	5	670750840227
EPXMA1234	1/2 in. PEX x 3/4 in. MPT	5	670750841170
EPXMS1234	1/2 in. PEX x 3/4 in. MS	5	670750849435
EPXMA3412	3/4 in. PEX x 1/2 in. MPT	5	670750841453
EPXMA3410PK	3/4 in. PEX x MPT (10 Pack)	5	670750841071
EPXMS3410PK	3/4 in. PEX x MS (10 Pack)	5	670750840258
EPXMA341	3/4 in. PEX x 1 in. MPT	5	670750844027
EPXMS341	3/4 in. PEX x 1 in. MS	5	670750853548
EPXMA134	1 in. PEX x 3/4 in. MPT	5	670750841095
EPXMA11	1 in. PEX x MPT	5	670750841118
EPXMSA115PK	1 in. PEX x MS (5 Pack)	5	670750840272

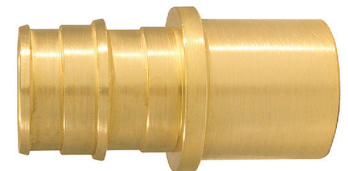
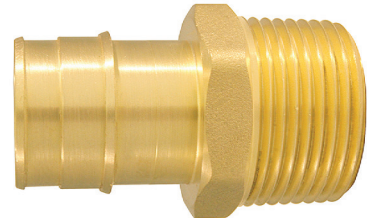

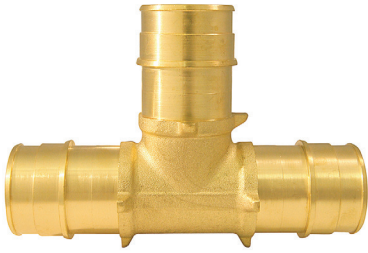

Part Number	Description	Carton Qty	UPC
BRASS TEES			
EPXT1210PK	1/2 in. (10 Pack)	5	670750840364
EPXT121234	1/2 in. x 1/2 in. x 3/4 in.	5	670750840388
EPXT341212	3/4 in. x 1/2 in. x 1/2 in.	5	670750840401
EPXT341234	3/4 in. x 1/2 in. x 3/4 in.	5	670750840418
EPXT3434125PK	3/4 in. x 3/4 in. x 1/2 in. (5 Pack)	5	670750840432
EPXT345PK	3/4 in. (5 Pack)	5	670750896545
EPXT1112	1 in. x 1 in. x 1/2 in.	5	670750840531
EPXT1134	1 in. x 1 in. x 3/4 in.	5	670750840562
EPXT11	1 in.	5	670750840784



VALVES			
EPXVA1214C	1/2 in. PEX x 1/4 in. C Angle	10	670750845543
EPXVS1214C	1/2 in. PEX x 1/4 in. C Str	10	670750839481
EPXVA1238C	1/2 in. PEX x 3/8 in. C Angle	10	670750840135
EPXVS1238C	1/2 in. PEX x 3/8 in. C Str	10	670750839559



EPXSCV1234	1/2 in. PEX x 3/4" GHT	5	670750840968
------------	------------------------	---	--------------



EPXV12	1/2 in. Ball Valve	5	670750839368
EPXV34	3/4 in. Ball Valve	5	670750839375
EPXV1	1 in. Ball Valve	5	670750839382

Part Number	Description	Carton Qty	UPC
POLY ALLOY COUPLINGS			
EPXPAC1210PK	1/2 in. (10 Pack)	5	670750842566
EPXPAC3410PK	3/4 in. (10 Pack)	5	670750842573
EPXPAC1110PK	1 in. (10 Pack)	5	670750842719

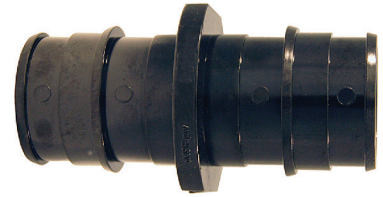

POLY ALLOY ELBOWS			
EPXPAE1210PK	1/2 in. (10 Pack)	5	670750842757
EPXPAE3410PK	3/4 in. (10 Pack)	5	670750842764
EPXPAE15PK	1 in. (5 Pack)	5	670750842771



POLY ALLOY MALE ADAPTER			
EPXPAM1210PK	1/2 in. PEX x 1/2 in. MPT (10 Pack)	5	670750842788



POLY ALLOY TEST PLUGS			
EPXPAP1210PK	1/2 in. (10 Pack)	5	670750842795
EPXPAP3410PK	3/4 in. (10 Pack)	5	670750842801
EPXPAP110PK	1 in. (10 Pack)	5	670750842832



POLY ALLOY TEES			
EPXPAT1210PK	1/2 in. (10 Pack)	5	670750842849
EPXPAT3410PK	3/4 in. (10 Pack)	5	670750842863
EPXPAT15PK	1 in. (5 Pack)	5	670750896057



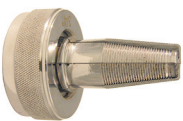
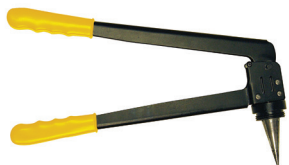

Part Number Description Carton Qty UPC

MISCELLANEOUS

EPXCSST18	3/4 in. PEX x 3/4 in. FPT x 18 in. CSST Water Heater Connector	5	670750840234
EPXSTUBWE12	1/2 in. x 8 in. Stubout w/Ear	10	670750840142
EPXSTUBWE34	3/4 in. x 8 in. Stubout w/Ear	10	670750840159

MANIFOLDS

EPXM2PT0	3/4 in. Inlet - 2 Port, Open	5	670750842900
EPXM3PT0	3/4 in. Inlet - 3 Port, Open	5	670750842924
EPXM4PT	3/4 in. Inlet - 4 Port	5	670750842887
EPXM4PT0	3/4 in. Inlet - 4 Port, Open	5	670750842931
EPXM6PT	3/4 in. Inlet - 6 Port	5	670750842894

EXPANSION TOOLS

EPXTOOL	Expansion PEX Tool (No Heads)	3	670750843006
EPXTOOLKIT	1/2 in. - 1 in. Expansion PEX Tool Kit	3	670750842948
EPXHEAD12	1/2 in. Tool Head	5	670750842955
EPXHEAD34	3/4 in. Tool Head	5	670750842979
EPXHEAD1	1 in. Tool Head	5	670750842993

EXPANSION SLEEVES

EPXS1225PK	1/2" F1960 SLEEVE - 25PK	10	670750841378
EPXS3425PK	3/4" F1960 SLEEVE - 25PK	10	670750841545
EPXS125PK	1" F1960 SLEEVE - 25PK	10	670750842191

EXPANSION PEX PIPE (PEX-A)

PEX tubing is cross-linked, high-density polyethylene. It's available in white, red, or blue colors for easy identification of hot and cold water lines. The Apollo® PEX tubing listed in the following pages is type PEX-A (PE-Xa, PEXa).

PEX tubing is for use in hot and cold potable water distribution systems as well as hydronic radiant heating systems. PEX tubing can also be used in continuously recirculating plumbing systems up to 140° F while maintaining chlorine resistance.

Features

- Tough
- Flexible
- Less expensive than other plumbing materials
- Copper tube size dimensions (CTS)
- Available in white, red, or blue

Standards / Certifications

- PEX 5006 - SDR 9
- Meets ASTM F876/F877
- cNSFus-pw/rfh
- ANSI/NSF Standards 61 & 14
- cUPC
- CSA B137.5

Pressure & Temperature

- 160 psi @ 73° F, 100 psi @ 180° F

Installation

To cut PEX tubing, use a PEX tubing cutter and cut at a 90° angle. Clear the cut end of any burrs or debris. **Do not expose PEX tubing to direct sunlight.**

It is recommended to insulate hot water lines with standard foam polyethylene pipe insulation to prevent heat loss. If installing in an area that experiences harsh winters, it's recommended to insulate both hot and cold water lines to prevent freezing.

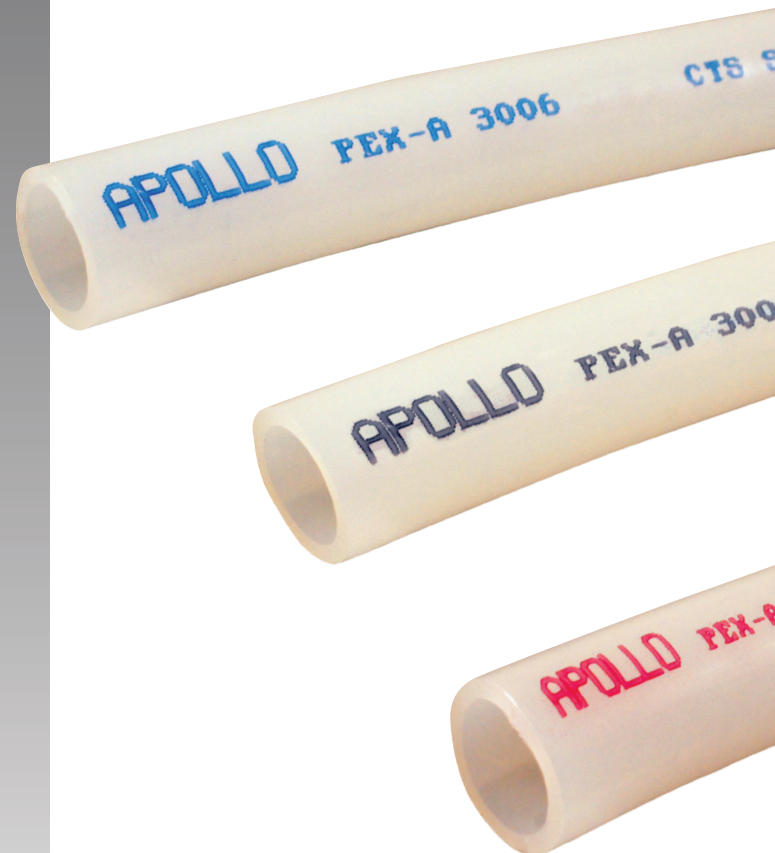

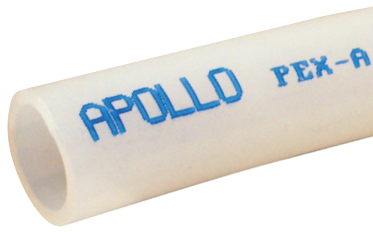

Part Number	Description	Carton Qty	UPC
BLUE EXPANSION PEX PIPE			
EPPB10012	1/2 in. x 100 ft. Coil	1	670750843051
EPPB30012	1/2 in. x 300 ft. Coil	1	670750843075
EPPB10034	3/4 in. x 100 ft. Coil	1	670750843235
EPPB30034	3/4 in. x 300 ft. Coil	1	670750843242
EPPB1001	1 in. x 100 ft. Coil	1	670750843501
EPPB3001	1 in. x 300 ft. Coil	1	670750843556



Part Number	Description	Carton Qty	UPC
RED EXPANSION PEX PIPE			
EPPR10012	1/2 in. x 100 ft. Coil	1	670750843044
EPPR30012	1/2 in. x 300 ft. Coil	1	670750843112
EPPR10034	3/4 in. x 100 ft. Coil	1	670750843228
EPPR30034	3/4 in. x 300 ft. Coil	1	670750843259
EPPR1001	1 in. x 100 ft. Coil	1	670750843426
EPPR3001	1 in. x 300 ft. Coil	1	670750843617



Part Number	Description	Carton Qty	UPC
WHITE EXPANSION PEX PIPE			
EPPW512	1/2 in. x 5 ft. Stick	25	670750843013
EPPW10012	1/2 in. x 100 ft. Coil	1	670750843037
EPPW30012	1/2 in. x 300 ft. Coil	1	670750843136
EPPW534	3/4 in. x 5 ft. Stick	10	670750843143
EPPW10034	3/4 in. x 100 ft. Coil	1	670750843211
EPPW30034	3/4 in. x 300 ft. Coil	1	670750843266
EPPW51	1 in. x 5 ft. Stick	5	670750843273
EPPW1001	1 in. x 100 ft. Coil	1	670750843280
EPPW3001	1 in. x 300 ft. Coil	1	670750843693

APPLIANCE ACCESSORIES

Apollo is now offering a wide range of appliance accessories! New products - such as Tank Max, which provides more hot water from your existing water heater - to connectors and fittings.

New Products

- Tank Max - More Hot Water
- Tank Tee
- Tank Pro
- Water Heater Installation Kit With Push Technology!

Other Appliance Products

- Push Connectors
- Corrugated Stainless Steel Connectors
- Corrugated Copper Connectors
- Braided Stainless Steel Connectors
- PVC Connectors/Drain Hoses
- Fittings
- Valves



Appliance

Part Number	Description	Carton Qty	UPC
DISHWASHER CONNECTORS			



AFDWF5	5 ft. PVC Connector	6	670750729287
--------	---------------------	---	--------------



AFDWD6	6 ft. PVC Drain Hose	6	670750729294
--------	----------------------	---	--------------

DISHWASHER FITTINGS			
----------------------------	--	--	--



AFDWE38C34	3/8 in. OD Comp x 3/4 in. FGH 90° Elbow	5	670750729614
------------	---	---	--------------



AFDOSCOMP	1/2 in. x 3/8 in. x 3/8 in. Dual Outlet Stop Valve	5	670750729874
-----------	--	---	--------------

ICEMAKER CONNECTOR			
---------------------------	--	--	--



AFIM5	5 ft. PVC Connector	8	670750729324
-------	---------------------	---	--------------

ICEMAKER VALVE			
-----------------------	--	--	--



AFQCSTOP	3/8 in. x 3/8 in. x 1/4 in. Push Stop Valve	5	670750729638
----------	---	---	--------------

Part Number Description Carton Qty UPC

WASHING MACHINE CONNECTORS

AFWMF6 6 ft. PVC Connector 12 670750729218



AFWMD6 6 ft. PVC Drain Hose 6 670750729256



WASHING MACHINE FITTINGS

AFPF122PK 1/2 in. Push X 1/2 in. FIP Adapter (2 Pack) 5 670750729348



AF45E2PK 3/4 in. MIP X 3/4 in. FGH 45° Elbow 12 670750729409



AF90E2PK 3/4 in. MIP X 3/4 in. FGH 90° Elbow 12 670750729591



BHPWMSV 1/2 in. Push X 1/2 in. MGH Straight Valve 5 670750450044



BHPWMAV 1/2 in. Push X 1/2 in. MGH Angle Valve 5 670750450228



Part Number	Description	Carton Qty	UPC
CORRUGATED COPPER CONNECTORS			



WHC34F34S18	3/4 in. FIP x 3/4 in. SWT x 18 in.	5	670750459993
WHC34F24	3/4 in. FIP x 3/4 in. FIP x 24 in.	20	670750460029

BRAIDED STAINLESS STEEL CONNECTORS			
---	--	--	--



10188857	1/2 in. P x 3/4 in. FIP x 20 in.	5	683264888579
WHBS34F12	3/4 in. FIP x 3/4 in. FIP x 12 in.	5	670750460128
WHBS34F18	3/4 in. FIP x 3/4 in. FIP x 18 in.	10	670750460135
WHBS34F24	3/4 in. FIP x 3/4 in. FIP x 24 in.	5	670750460142
10188852	3/4 in. P x 3/4 in. FIP x 20 in.	5	683264888524
WHBS34F7818	3/4 in. FIP x 7/8 in. FIP x 18 in.	5	670750460104

CORRUGATED STAINLESS STEEL CONNECTORS			
--	--	--	--



10155563	1/2 in. P x 3/4 in. FIP x 12 in.	20	683264555631
10155564	1/2 in. P x 3/4 in. FIP x 15 in.	20	683264555648
10155565	1/2 in. P x 3/4 in. FIP x 18 in.	20	683264555655
10155566	1/2 in. P x 3/4 in. FIP x 21 in.	20	683264555662
10155567	3/4 in. P x 3/4 in. FIP x 12 in.	20	683264555679
10155568	3/4 in. P x 3/4 in. FIP x 15 in.	20	683264555686
10155569	3/4 in. P x 3/4 in. FIP x 18 in.	20	683264555693
10155570	3/4 in. P x 3/4 in. FIP x 21 in.	20	683264555709
WHCSST34F24	3/4 in. FIP x 3/4 in. FIP x 24 in.	5	670750460173
WHCSST34P1F24	3/4 in. P x 1 in. FIP x 24 in.	5	670750570971
WHCSST1F18	1 in. FIP x 1 in. FIP x 18 in.	5	670750459542

FITTINGS			
-----------------	--	--	--



WHCOMP12C34M	1/2 in. C x 3/4 in. MIP (2 Pack)	5	670750459429
WHCOMP34	3/4 in. C x 3/4 in. MIP (2 Pack)	5	670750459412

TANK MAX

Part Number	Description	Carton Qty	UPC
69TANKMAX	Almost doubles hot water output from an existing water heater	3	670750361838



TANK PRO

69TANKPRO	Replaces the expansion tank, dielectric union, shutoff valve and tee with one device	5	670750361715
-----------	--	---	--------------



TANK TEE

69TANKTEE	Attach an expansion tank quicker and easier	5	670750361821
-----------	---	---	--------------



WATER HEATER INSTALLATION KIT

69TANKKIT	Contains Tank Tee, 18 in. connector, 12 in. connector with ball valve	3	670750430992
-----------	---	---	--------------



WATER SOFTENER FITTINGS

AFWS34	3/4 in. Push (2 Pack)	5	670750519802
AFWS1	1 in. Push (2 Pack)	5	670750519819



PUSH TO CONNECT

TECTITE™
by "Apollo"



"Apollo"
**PUSH
COPPER**

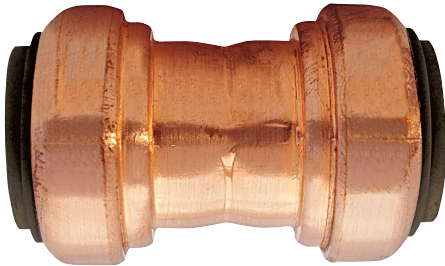

Copper LOC™



Removable PUSH Fittings sizes ¼ in. to 1 in.

Tectite by Apollo is proud to offer the most complete portfolio of push fittings available in the marketplace. It is a full line of 1/4 in. - 1 in. lead free push fittings. Our push fittings can be used with copper, CPVC, or PEX pipe.

Apollo Copper Push fittings are removeable and reusable.

CopperLOC™ fittings eliminate the need to obtain a 'Hot Work' permit, which can have costly insurance implications. The potential for flame damage is removed. No more solder, flux, heat, adhesives, threading machings or special pressing tools needed! CopperLOC™ fittings are non-removeable.

FEATURES

- Use in wet or dry installations.
- Reduce repair or installation time.
- No special installation tools required.
- Joins copper, CPVC, and PEX tubing.
- Tectite and Apollo Copper Push are removable and reusable.
- EPDM o-ring for leak free seals.

PERFORMANCE RATING

- Maximum pressure: 200 psi
- Temperature range: 32°F to 200°F

APPROVALS

- NSF/ANSI NSF 61/372/14
- ASSE 1061
- IAPMO cUPC® File Listings: 4951

Part Number	Description	Carton Qty	UPC
COUPLINGS			
FSBC14	1/4 in.	12	670750964572
FSBC38	3/8 in.	12	670750966026
FSBC1238	1/2 in. x 3/8 in.	12	670750964237
FSBC12	1/2 in.	24	670750903823
FSBC124PK	1/2 in. (4 Pack)	12	670750964282
FSBC3412	3/4 in. x 1/2 in.	12	670750964626
FSBC34	3/4 in.	24	670750903847
FSBC134	1 in. x 3/4 in.	6	670750964329
FSBC1	1 in.	6	670750963445

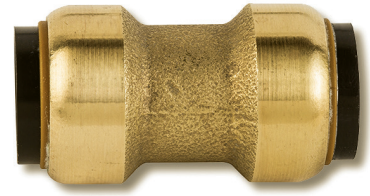

Push

SLIP COUPLINGS			
FSBC12SL	1/2 in.	6	670750969461
FSBC34SL	3/4 in.	6	670750969539
FSBC1SL	1 in.	3	670750969485



CONVERSION COUPLINGS			
FSBIPSC12	1/2 in. IPS x 1/2 in. CTS	6	670750968990
FSBIPSC34	3/4 in. IPS x 3/4 in. CTS	6	670750969003
FSBIPSC1	1 in. IPS x 1 in. CTS	3	670750968013
FSBPBC12	1/2 in. Push x 1/2 in. PB	12	670750966453
FSBPBC34	3/4 in. Push x 3/4 in. PB	6	670750966651

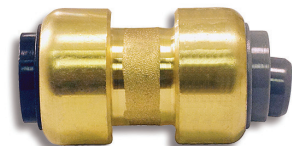
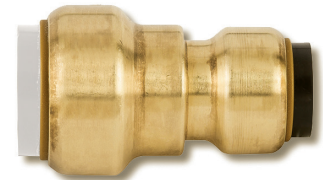

ELBOWS			
FSBE38	3/8 in.	6	670750966965
FSBE12	1/2 in.	24	670750966927
FSBE124PK	1/2 in. (4 Pack)	12	670750966934
FSBE3412	3/4 in. x 1/2 in.	6	670750966958
FSBE34	3/4 in.	24	670750966941
FSBE1	1 in.	3	670750966866





Part Number	Description	Carton Qty	UPC
DROP EAR ELBOWS			
FSBDEE3812	3/8 in. x 1/2 in. FPT	12	670750966835
FSBDEE12	1/2 in. x 1/2 in. FPT	12	670750966828
FSBDEE12P	1/2 in.	6	670750072178



FEMALE ELBOWS			
FSBDWE1434	1/4" x 3/4" FGHT Dishwasher Elbow	6	670750966859
FSBFE12	1/2" x 1/2" FNPT	12	670750967092



MALE ELBOWS			
FSBME1438	1/4 in. x 3/8 in. MNPT Dishwasher Elbow	6	670750967382
FSBME1238	1/2 in. x 3/8 in. MNPT	6	670750967177
FSBME12	1/2 in. x 1/2 in. MNPT	6	670750967153

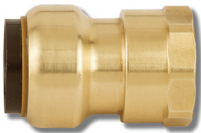

FEMALE ADAPTERS			
FSBFA1412	1/4 in. x 1/2 in. FNPT	12	670750967887
FSBFA3812	3/8 in. x 1/2 in. FNPT	12	670750967955
FSBFA12	1/2 in. x 1/2 in. FNPT	24	670750967603
FSBFA124PK	1/2 in. x 1/2 in. FNPT (4 Pack)	12	670750967634
FSBFA1234	1/2 in. x 3/4 in. FNPT	6	670750967610
FSBFA34	3/4 in. x 3/4 in. FNPT	12	670750967931
FSBFA1	1 in. x 1 in. FNPT	3	670750967542

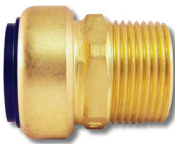

MALE ADAPTERS			
FSBMA1412	1/4 in. x 1/2 in. MNPT	6	670750969287
FSBMA3812	3/8 in. x 1/2 in. MNPT	12	670750969393
FSBMA12	1/2 in. x 1/2 in. MNPT	24	670750969225
FSBMA1234	1/2 in. x 3/4 in. MNPT	6	670750969256
FSBMA3412	3/4 in. x 1/2 in. MNPT	6	670750969362
FSBMA34	3/4 in. x 3/4 in. MNPT	24	670750969317
FSBMA134	1 in. x 3/4 in. MNPT	3	670750969263
FSBMA1	1 in. x 1 in. MNPT	3	670750969195

Part Number	Description	Carton Qty	UPC
MALE CONVERSION ADAPTERS			
FSBIPSMA12	1/2 in. IPS x 1/2 in. MNPT	6	670750969072
FSBIPSMA34	3/4 in. IPS x 3/4 in. MNPT	6	670750969089

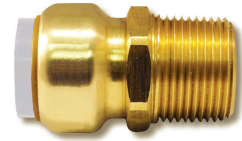

TEES			
FSBT14	1/4 in.	6	670750983450
FSBT38	3/8 in.	6	670750983542
FSBT121238	1/2 in. x 1/2 in. x 3/8 in.	12	670750983429
FSBT12	1/2 in.	24	670750983405
FSBT341212	3/4 in. x 1/2 in. x 1/2 in.	6	670750983511
FSBT341234	3/4 in. x 1/2 in. x 3/4 in.	6	670750983528
FSBT343412	3/4 in. x 3/4 in. x 1/2 in.	12	670750983535
FSBT34	3/4 in.	12	670750983504
FSBT1134	1 in. x 1 in. x 3/4 in.	3	670750983399
FSBT1	1 in.	3	670750983382

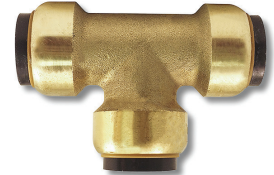

SLIP TEES			
FSBT12SL	1/2 in.	6	670750969546
FSBT12SLCTS	1/2 in. x 1/2 in. x 1/2 in. CTS Stem	6	670750969584
FSBT12SLF	1/2 in. x 1/2 in. x 1/2 in. FNPT	6	670750969614
FSBT34SL	3/4 in.	6	670750969676
FSBT34SLF	3/4 in. x 3/4 in. x 3/4 in. FNPT	6	670750969683



FEMALE TEES			
FSBT34F	3/4 in. x 3/4 in. x 3/4 in. FNPT	6	670750073687
FSBTANKTEE	TANKTEE - 3/4 in. x 3/4 in. FNPT x 3/4 in. FNPT	5	670750081729





Part Number	Description	Carton Qty	UPC
CAPS			
FSBCAP38	3/8 in.	12	670750961847
FSBCAP12	1/2 in.	24	670750961014
FSBCAP124PK	1/2 in. (4 Pack)	12	670750961199
FSBCAP12WD	1/2 in. with Drain	12	670750073410
FSBCAP34	3/4 in.	12	670750961236
FSBCAP34WD	3/4 in. with Drain	12	670750073670
FSBCAP1	1 in.	3	670750960673

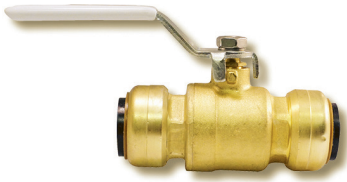

Part Number	Description	Carton Qty	UPC
VALVES			
FSBBV12	1/2 in. Ball Valve	12	670750959622
FSBBV12DE	1/2 in. Ball Valve with Drain	12	670750959639
FSBBV12F	1/2 in. x 1/2 in. FNPT Ball Valve	6	670750959653
FSBBV12SL	1/2 in. Slip Ball Valve	6	670750959738
FSBBV34	3/4 in. Ball Valve	12	670750959769
FSBBV34DE	3/4 in. Ball Valve with Drain	6	670750959776
FSBBV34F	3/4 in. x 3/4 in. FNPT Ball Valve	6	670750959844
FSBBV34SL	3/4 in. Slip Ball Valve	6	670750959875
FSBBV1	1 in. Ball Valve	6	670750959523
FSBVA1214	1/2 in. x 1/4 in. Ang. Stop Valve	6	670750969768
FSBVS1214	1/2 in. x 1/4 in. Str. Stop Valve	6	670750970016
FSBVA1214C	1/2 in. x 1/4 in. OD Comp Angle Stop Valve	6	670750969843
FSBVS1214C	1/2 in. x 1/4 in. OD Comp Straight Stop Valve	6	670750970030
FSBVA1238C	1/2 in. x 3/8 in. OD Comp Angle Stop Valve	12	670750969850
FSBVS1238C	1/2 in. x 3/8 in. OD Comp Straight Stop Valve	12	670750981623
FSBVA1212M	1/2 in. x 1/2 in. MNPT Angle Stop Valve	6	670750969751
FSBVS1212M	1/2 in. x 1/2 in. MNPT Straight Stop Valve	6	670750969867
FSBVT121238C	1/2 in. x 1/2 in. x 3/8 in. OD Comp Tee Valve	6	670750983313
FSBVT121214C	1/2 in. x 1/2 in. x 1/4 in. OD Comp Tee Valve	6	670750983269
FSBVT343414C	3/4 in. x 3/4 in. x 1/4 in. Comp Tee Valve	6	670750983375



Part Number	Description	Carton Qty	UPC
VALVES (cont.)			
FSBCV12	1/2 in. Check Valve	12	670750963018
FSBCV34	3/4 in. Check Valve	12	670750963070
FSBWMAV	1/2 in. x 3/4 in. MHT Washing Machine Ang. Valve	6	670750072192
FSBWMSV	1/2 in. x 3/4 in. MHT Washing Machine Str. Valve	6	670750072406
FSBPRV34	3/4 in. Pressure Regulator	3	670750969430
FSBPRV34SL	3/4 in. Slip Pressure Regulator	2	670750969447



CONNECTORS			
FSBBS12P18	1/2 in. x 18 in. Repair Hose	12	670750960161
FSBBS34P18	3/4 in. x 18 in. Repair Hose	12	670750960543
FSBBS34F12	3/4 in. x 3/4 in. FNPT x 12 in. Water Heater Connector	12	670750960192
FSBBS34F15	3/4 in. x 3/4 in. FNPT x 15 in. Water Heater Connector	12	670750960314
FSBBS34F18	3/4 in. x 3/4 in. FNPT x 21 in. Water Heater Connector	12	670750960321
FSBBS34F18BV	3/4 in. x 3/4 in. FNPT x 21 in. Water Heater Conn. w/ Ball Valve	12	670750960352
FSBBS34F24	3/4 in. x 3/4 in. FNPT x 24 in. Water Heater Connector	12	670750960383
FSBBS34P1F24	3/4 in. x 1 in. FNPT x 24 in. Water Softener Connector	6	670750960550
FSBCSST34F18	3/4 in. x 3/4 in. FNPT x 18 in. CSST Water Heater Connector	12	670750966804
FSBCSST34F24	3/4 in. x 3/4 in. FNPT x 24 in. CSST Water Heater Connector	12	670750966811
FSBWHKIT	Water Heater Installation Kit	3	670750996047

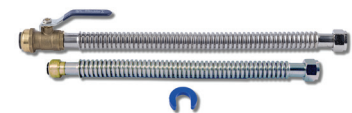

Part Number	Description	Carton Qty	UPC
MISCELLANEOUS			
FSBBOXIM	Ice Maker Outlet Box	2	670750959899
FSBBOXIMWH	Ice Maker Outlet Box w/ Water Hammer Arrestors	2	670750959905
FSBBOXWM	Washing Machine Outlet Box	3	670750959936
FSBBOXWMWH	Washing Machine Outlet Box w/ Water Hammer Arrestors	3	670750960093
FSBFAU14	1/4 in. (3/8 in.) x 1/4 in. Comp Stop Valve Connector	6	670750967436
FSBFAU1438	1/4 in. x 3/8 in. Comp Faucet Connector	6	670750967474
FSBTA141438C	1/4 in. x 1/4 in. x 3/8 in. OD Comp Stop Valve Tee	6	670750983368
FSBFAU1412	1/4 in. x 1/2 in. FNPT Faucet Connector	6	670750967443
FSBFAU1478	1/4 in. x 7/8 in. BC Toilet Connector	6	670750967481
FSBSTUB8	1/2 in. x 8 in. Stub-Out Elbow	6	670750959493
FSBTWG34	3/4 in. x 3/4 in. x 1/2 in. Tee w/ Pressure Gauge	5	670750983559



Part Number	Description	Carton Qty	UPC
TOOLS			
69PFRT	Push Fitting Removal Tool Removes 1/2 in. - 1 in. fittings	3	670750570605
FSBDC14	1/4 in. Demount Clip	12	670750957482
FSBDC38	3/8 in. Demount Clip	12	670750957680
FSBDC12	1/2 in. Demount Clip	48	670750957383
FSBDC34	3/4 in. Demount Clip	48	670750957499
FSBDC1	1 in. Demount Clip	24	670750957376
FSBIPSDC3PK	1/2 in., 3/4 in. and 1 in. PVC IPS Demount Clip (3 Pack)	12	670750969010
FSBDT12	1/2 in. Removal Tool	6	670750074165
FSBDT34	3/4 in. Removal Tool	6	670750074233
FSBDG	3/8 in. - 1 in. Depth Gauge and Chamfering Tool	6	670750958038



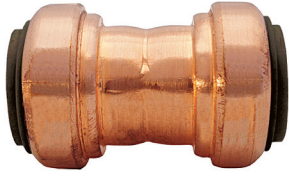

Part Number	Description	Carton Qty	UPC
COUPLINGS			
ACPC12	1/2 in.	15	670750838958
ACPC3412	3/4 in. x 1/2 in.	15	670750839115
ACPC34	3/4 in.	15	670750839108



Part Number	Description	Carton Qty	UPC
ELBOWS			
ACPE12	1/2 in.	15	670750839177
ACPE34	3/4 in.	15	670750839184
ACPDEE12	1/2 in. x 1/2 in. FPT Drop Ear Elbow	15	670750839160

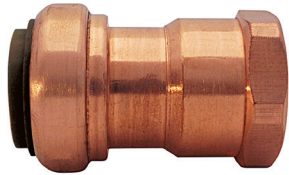

Part Number	Description	Carton Qty	UPC
FEMALE ADAPTERS			
ACPF12	1/2 in.	15	670750839191
ACPF1234	1/2 in. x 3/4 in. FPT	15	670750839207
ACPF34	3/4 in.	15	670750839214

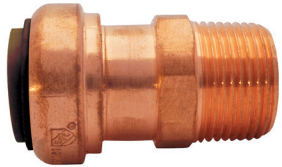

Part Number	Description	Carton Qty	UPC
MALE ADAPTERS			
ACPM12	1/2 in.	15	670750839221
ACPM1234	1/2 in. x 3/4 in. MPT	15	670750839238
ACPM34	3/4 in.	15	670750839245

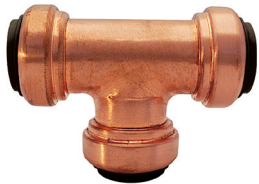

Part Number	Description	Carton Qty	UPC
TEES			
ACPT12	1/2 in.	15	670750839252
ACPT343412	3/4 in. x 3/4 in. x 1/2 in.	15	670750839276
ACPT34	3/4 in.	15	670750839269



Part Number	Description	Carton Qty	UPC
CAPS			
ACPCAP12	1/2 in.	15	670750839139
ACPCAP34	3/4 in.	15	670750839146

Part Number	Description	Carton Qty	UPC
COUPLING			
10170700	1/2 in.	15	683264707009
10170705	3/4 in.	15	683264707054
10170715	3/4 in. x 1/2 in.	15	683264707153



FEMALE ADAPTER			
10170730	1/2 in.	15	683264707306
10170735	3/4 in.	15	683264707351



MALE ADAPTER			
10170745	1/2 in.	15	683264707450
10170750	3/4 in.	15	683264707504



45° ELBOW			
10170760	1/2 in.	15	683264707603
10170765	3/4 in.	15	683264707658



90° ELBOW			
10170790	1/2 in.	15	683264707900
10170795	3/4 in.	15	683264707955



DROP EAR ELBOW			
10170835	1/2 in.	15	683264708358

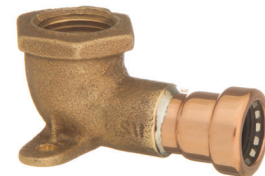



Part Number	Description	Carton Qty	UPC
MALE ELBOW			

10170840	1/2 in.	15	683264708402
10170845	3/4 in.	15	683264708457



FEMALE ELBOW			
---------------------	--	--	--

10170820	1/2 in.	15	683264708204
10170825	3/4 in.	15	683264708259



TEE			
------------	--	--	--

10170855	1/2 in.	15	683264708556
10170860	3/4 in.	15	683264708600
10170870	3/4 in. x 3/4 in. x 1/2 in.	15	683264708709



TUBE CAP			
-----------------	--	--	--

10170885	1/2 in.	15	683264708853
10170890	3/4 in.	15	683264708907

APOLLOXPRESS

The APOLLOXPRESS line of fittings and valves features pre-lubricated seals and "Leak Before Press"® technology to ensure quick and confident connections. Both small diameter and large diameter fittings are compatible with most commercially-available press-fit tools. APOLLOXPRESS valves are available in both standard and lead free configurations, while all APOLLOXPRESS fittings are lead free.

Features

- American made quality you can depend on.
- Mechanical Leak Before Press® on small diameter, within a 120° turn.
- Deepest cup depth on the market.
- Radial orientation on installation is not necessary.
- Unique floating flanges can be put back in place during installation.
- 100% water tested weld or press.

Approvals

- IAPMO listed to NSF 61, NSF 372, IAPMO PS-117 and CSA TIL-MSE-13 standards
- ICC International Plumbing Code
- UPC Uniform Plumbing Code
- National Standard Plumbing Code

APOLLOXPRESS

YOUR SINGLE SOURCE SOLUTION FOR PRESS TECHNOLOGY



Press





Part Number	Description	Carton Qty	UPC
COUPLINGS			
10176002	1/2 in.	15	683264760028
10076402	1/2 in. Bulk Pack	40	683264764026
10176016	1/2 in. Repair Coupling	20	683264760165
10176004	3/4 in.	15	683264760042
10076404	3/4 in. Bulk Pack	20	683264764040
10176018	3/4 in. Repair Coupling	15	683264760189
10176030	3/4 in. x 1/2 in.	15	683264760301
10176320	3/4 in. x 1/2 in. Reducer	15	683264763203
10176006	1 in.	10	683264760066
10076406	1 in. Bulk Pack	15	683264764064
10176020	1 in. Repair Coupling	10	683264760202



TEES			
10176240	1/2 in.	15	683264762404
10176242	3/4 in.	10	683264762428
10176254	3/4 in. x 3/4 in. x 1/2 in.	10	683264762541
10176244	1 in.	5	683264762442



90° ELBOWS			
10176194	1/2 in.	15	683264761940
10076594	1/2 in. Bulk Pack	30	683264765948
10176216	1/2 in. Street Elbow	20	683264762169
10176228	1/2 in. Drop Ear Elbow Bulk Pk	10	683264762282
10176196	3/4 in.	15	683264761964
10076596	3/4 in. Bulk Pack	20	683264765962
10176218	3/4 in. Street Elbow	15	683264762183
10176198	1 in.	10	683264761988

Part Number	Description	Carton Qty	UPC
45° ELBOWS			
10176170	1/2 in.	15	683264761704
10176184	3/4 in. Street Elbow	15	683264761841
10176172	3/4 in.	15	683264761728



MALE ADAPTERS			
10176130	1/2 in.	15	683264761308
10076530	1/2 in. Bulk Pack	40	683264765306
10176132	3/4 in.	20	683264761322
10176134	1 in.	10	683264761346

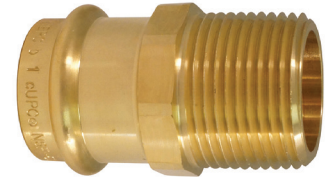

FEMALE ADAPTERS			
10176092	1/2 in.	15	683264760929
10176094	3/4 in.	15	683264760943
10176096	1 in.	10	683264760967



CAPS			
10176300	1/2 in.	20	683264763005
10176302	3/4 in.	15	683264763029



BALL VALVES			
77WLF10301	1/2 in.	1	670750508837
77WLF10401	3/4 in.	1	670750508844
77WLF10501	1 in.	1	670750508851



PRESS FAST TOOL

69PFT	Press Fast Tool	1	670750096693
-------	-----------------	---	--------------



WROT COPPER FITTINGS



The production of copper fittings is environmentally safe, and the industry is the undisputed leader in recycling. Over half of the copper used in manufacturing EPC copper fittings is from recycled sources.

Features

- Lightweight but strong
- Corrosion resistant
- Biostatic and inhibits bacterial growth on its surface
- Non-flammable
- Not affected by sunlight
- Cannot produce toxic fumes in a fire

Approvals

- IAPMO
- UPC - ANSI/NSF 61 for Cu
- Standards Council of Canada

Part Number	Description	Carton Qty	UPC
COUPLING WITH STOP			
30896	1/4 in.	50	683264308961
30898	3/8 in.	50	683264308985
30900	1/2 in.	100	683264309005
30902	5/8 in.	25	683264309029
30904	3/4 in.	50	683264309043
30908	1 in.	25	683264309081
30910	1¼ in.	20	683264309104
30914	1½ in.	10	683264309142
30916	2 in.	5	683264309166

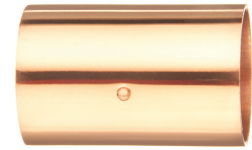

COUPLING WITH ROLL STOP			
30666	1/8 in.	50	683264306660



COUPLING WITHOUT STOP			
30952	1/2 in.	100	683264309524
30956	3/4 in.	50	683264309562
30960	1 in.	25	683264309609
30962	1¼ in.	20	683264309623
30964	1½ in.	10	683264309647
30966	2 in.	5	683264309661

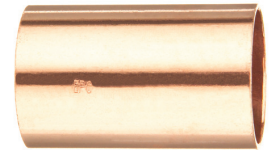

UNION			
33578	3/8 in.	25	683264335783
33580	1/2 in.	25	683264335806
33582	3/4 in.	20	683264335820
33584	1 in.	10	683264335844
33585	1¼ in.	5	683264335851
33586	1½ in.	5	683264335868
33587	2 in.	2	683264335875



Solder

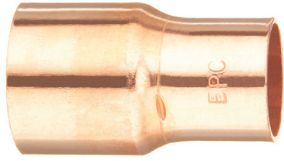

Part Number	Description	Carton Qty	UPC
REDUCER COUPLING WITH STOP			
30688	3/8 in. x 1/4 in.	50	683264306882
30696	1/2 in. x 3/8 in.	50	683264306967
30698	1/2 in. x 1/4 in.	50	683264306981
30716	3/4 in. x 1/2 in.	50	683264307162
30734	1 in. x 3/4 in.	25	683264307346
30738	1 in. x 1/2 in.	25	683264307384
30748	1 1/4 in. x 1 in.	10	683264307483
30752	1 1/4 in. x 3/4 in.	10	683264307520
30756	1 1/4 in. x 1/2 in.	10	683264307568
30766	1 1/2 in. x 1 1/4 in.	10	683264307667
30768	1 1/2 in. x 1 in.	10	683264307681
30776	1 1/2 in. x 1/2 in.	10	683264307766
30772	1 1/2 in. x 3/4 in.	10	683264307728
30784	2 in. x 1 1/2 in.	10	683264307841



FEMALE ADAPTER			
30120	3/8 in.	50	683264301207
30130	1/2 in.	50	683264301306
30150	3/4 in.	25	683264301504
30160	1 in.	20	683264301603
30170	1 1/4 in.	10	683264301702
30180	1 1/2 in.	10	683264301801
30190	2 in.	5	683264301900

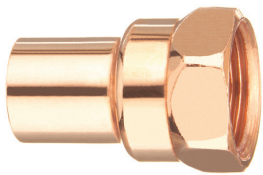

FEMALE STREET ADAPTER			
30236	1/2 in.	50	683264302365
30242	3/4 in.	25	683264302426

Part Number	Description	Carton Qty	UPC
FEMALE REDUCING ADAPTER			
30124	3/8 in. C x 1/2 in. FPT	50	683264301245
30134	1/2 in. C x 3/4 in. FPT	25	683264301344
30136	1/2 in. C x 3/8 in. FPT	50	683264301368
30138	1/2 in. C x 1/4 in. FPT	50	683264301382
30154	3/4 in. C x 1 in. FPT	20	683264301542
30156	3/4 in. C x 1/2 in. FPT	25	683264301566
30166	1 in. C x 3/4 in. FPT	25	683264301665



MALE ADAPTER			
30280	1/8 in.	50	683264302808
30290	1/4 in.	50	683264302907
30300	3/8 in.	50	683264303003
30310	1/2 in.	50	683264303102
30330	3/4 in.	25	683264303300
30342	1 in.	20	683264303423
30354	1 1/4 in.	10	683264303546
30368	1 1/2 in.	10	683264303683
30378	2 in.	5	683264303782

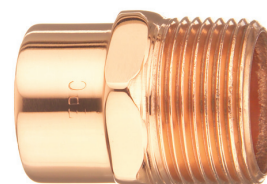

MALE STREET ADAPTER			
30436	1/2 in.	50	683264304369
30444	3/4 in.	25	683264304444

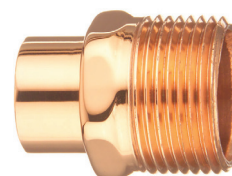

MALE REDUCING ADAPTER			
30304	3/8 in. C x 1/2 in. MPT	50	683264303041
30316	1/2 in. C x 3/4 in. MPT	25	683264303164
30318	1/2 in. C x 3/8 in. MPT	50	683264303188
30336	3/4 in. C x 1 in. MPT	20	683264303362
30338	3/4 in. C x 1/2 in. MPT	25	683264303386
30348	1 in. C x 3/4 in. MPT	25	683264303485





Part Number	Description	Carton Qty	UPC
45° ELBOW			
31090	3/8 in.	50	683264310902
31096	1/2 in.	100	683264310964
31106	3/4 in.	50	683264311060
31120	1 in.	25	683264311206
31128	1¼ in.	25	683264311282
31134	1½ in.	20	683264311343
31140	2 in.	10	683264311404



Part Number	Description	Carton Qty	UPC
45° STREET ELBOW			
31194	1/2 in.	100	683264311947
31202	3/4 in.	50	683264312029
31206	1 in.	25	683264312067
31212	1¼ in.	25	683264312128
31216	1½ in.	20	683264312166
31220	2 in.	10	683264312203



Part Number	Description	Carton Qty	UPC
90° ELBOW			
31260	1/8 in.	50	683264312609
31262	1/4 in.	50	683264312623
31266	3/8 in.	50	683264312661
31272	1/2 in.	100	683264312722
31280	5/8 in.	25	683264312807
31288	3/4 in.	50	683264312883
31296	1 in.	20	683264312968
31306	1¼ in.	25	683264313064
31314	1½ in.	20	683264313149
31322	2 in.	10	683264313224

Part Number	Description	Carton Qty	UPC
90° STREET ELBOW			
31392	1/4 in.	50	683264313927
31396	3/8 in.	50	683264313965
31400	1/2 in.	100	683264314009
31408	3/4 in.	50	683264314085
31412	1 in.	20	683264314122
31416	1¼ in.	25	683264314160
31420	1½ in.	20	683264314207
31424	2 in.	10	683264314245

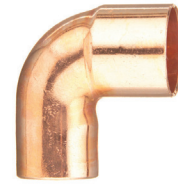

90° REDUCING ELBOW			
31290	3/4 in. x 1/2 in.	50	683264312906
31298	1 in. x 3/4 in.	25	683264312982

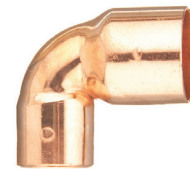

90° LONG TURN ELBOW			
31676	1/2 in.	50	683264316768
31684	5/8 in.	25	683264316843



TEE			
32606	1/8 in.	50	683264326064
32640	1/4 in.	50	683264326408
32668	3/8 in.	50	683264326682
32700	1/2 in.	50	683264327009
32768	3/4 in.	25	683264327689
32818	1 in.	10	683264328181
32866	1¼ in.	5	683264328662
32910	1½ in.	5	683264329102
32970	2 in.	5	683264329706

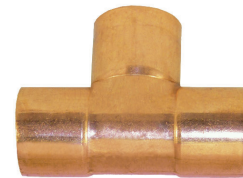



Part Number	Description	Carton Qty	UPC
BULLHEAD TEE			
32704	1/2 in. x 1/2 in. x 3/4 in.	25	683264327047
32770	3/4 in. x 3/4 in. x 1 in.	10	683264327702

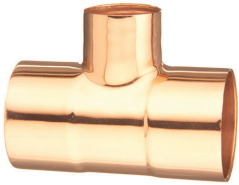

Part Number	Description	Carton Qty	UPC
REDUCING TEE			
32708	1/2 in. x 1/2 in. x 3/8 in.	50	683264327085
32774	3/4 in. x 3/4 in. x 1/2 in.	25	683264327740
32790	3/4 in. x 1/2 in. x 3/4 in.	25	683264327900
32794	3/4 in. x 1/2 in. x 1/2 in.	25	683264327948
32824	1 in. x 1 in. x 3/4 in.	10	683264328242
32828	1 in. x 1 in. x 1/2 in.	10	683264328280
32836	1 in. x 3/4 in. x 1 in.	10	683264328365
32838	1 in. x 3/4 in. x 3/4 in.	10	683264328389
32872	1 1/4 in. x 1 1/4 in. x 1 in.	5	683264328723
32874	1 1/4 in. x 1 1/4 in. x 3/4 in.	5	683264328747
32876	1 1/4 in. x 1 1/4 in. x 1/2 in.	5	683264328761
32882	1 1/4 in. x 1 in. x 1 1/4 in.	5	683264328822



Part Number	Description	Carton Qty	UPC
TUBE CAP			
30622	1/4 in.	50	683264306226
30624	3/8 in.	50	683264306240
30626	1/2 in.	100	683264306264
30628	5/8 in.	25	683264306288
30630	3/4 in.	50	683264306301
30632	1 in.	50	683264306325
30634	1 1/4 in.	25	683264306349
30636	1 1/2 in.	20	683264306363
30638	2 in.	10	683264306387

Part Number	Description	Carton Qty	UPC
FITTING REDUCER			
32044	3/8 in. x 1/4 in.	50	683264320444
32064	3/4 in. x 1/2 in.	50	683264320642
32072	1 in. x 3/4 in.	25	683264320727
32076	1 in. x 1/2 in.	25	683264320765
32084	1¼ in. x 3/4 in.	10	683264320840
32092	1½ in. x 1 in.	10	683264320925

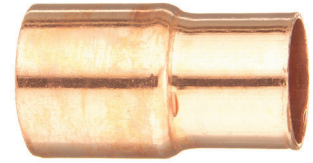

FLUSH BUSHING			
30536	1/2 in. x 3/8 in.	50	683264305366
30550	3/4 in. x 1/2 in.	50	683264305502
30556	1 in. x 3/4 in.	25	683264305564
30564	1¼ in. x 1 in.	25	683264305649
30570	1½ in. x 1¼ in.	20	683264305700
30580	2 in. x 1½ in.	5	683264305809



STUB OUT AIR CHAMBER			
32530	1/2 in. x 6 in.	100	683264325302



HI-EAR HANGER C			
31980	1/2 in.	100	683264319806





Part Number	Description	Carton Qty	UPC
COUPLING WITH STOP			
46230	1¼ in.	25	683264462304
46232	1½ in.	25	683264462328
46236	2 in.	10	683264462366

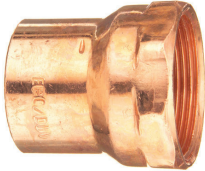

Part Number	Description	Carton Qty	UPC
FEMALE ADAPTER			
46002	1½ in.	10	683264460027
46004	2 in.	10	683264460041

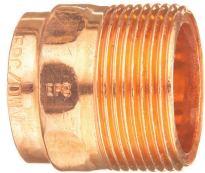

Part Number	Description	Carton Qty	UPC
MALE ADAPTER			
46040	2 in.	10	683264460409



Part Number	Description	Carton Qty	UPC
45° ELBOW			
46354	1½ in.	10	683264463547
46356	2 in.	5	683264463561



Part Number	Description	Carton Qty	UPC
90° ELBOW			
46412	1½ in.	10	683264464124
46416	2 in.	5	683264464162

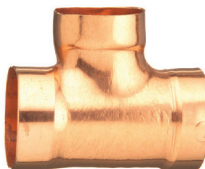

Part Number	Description	Carton Qty	UPC
SANITARY TEE			
46560	1¼ in.	10	683264465602
46562	1½ in.	10	683264465626
46570	2 in.	5	683264465701

Part Number	Description	Carton Qty	UPC
COUPLING WITH DRAIN			
34766	1/2 in.	75	683264347663
34767	3/4 in.	50	683264347670
34768	1 in.	25	683264347687

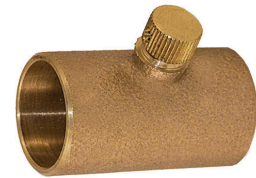

ELBOW WITH DRAIN			
35578	1/2 in.	50	683264355781
35580	3/4 in.	25	683264355804
35583	1 in.	10	683264355835



FEMALE ELBOW			
35306	1/2 in.	50	683264353060
35312	3/4 in.	30	683264353121
35317	1 in.	10	683264353176



FEMALE DROP EAR ELBOW			
35440	1/2 in.	25	683264354401
35445	3/4 in.	20	683264354456
35447	1 in.	10	683264354470



MALE ELBOW			
35365	1/2 in.	30	683264353657
35370	3/4 in.	30	683264353701
35376	1 in.	10	683264353763





Part Number	Description	Carton Qty	UPC
DROP EAR ELBOW			
35424	1/2 in.	50	683264354241
35426	3/4 in.	25	683264354265

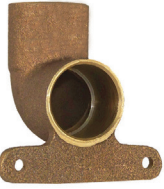

Part Number	Description	Carton Qty	UPC
HI EAR ELBOW			
35458	1/2 in.	50	683264354586
35459	3/4 in.	25	683264354593



Part Number	Description	Carton Qty	UPC
FEMALE HI EAR ELBOW			
35464	1/2 in.	40	683264354647
35466	3/4 in.	25	683264354661



Part Number	Description	Carton Qty	UPC
C X F X C TEE			
37528	1/2 in.	25	683264375284
37537	3/4 in.	20	683264375376
37545	1 in.	10	683264375451



Part Number	Description	Carton Qty	UPC
C X C X F TEE			
37409	1/2 in.	50	683264374096
37418	3/4 in.	10	683264374188
37427	1 in.	10	683264374270



Part Number	Description	Carton Qty	UPC
DROP EAR TEE			
37742	1/2 in.	25	683264377424

Part Number	Description	Carton Qty	UPC
DROP EAR ADAPTER			

34446	1/2 in.	50	683264344464
-------	---------	----	--------------



FLARED FEMALE ADAPTER			
------------------------------	--	--	--

42046	1/2 in.	10	683264420465
-------	---------	----	--------------

42062	3/4 in.	10	683264420625
-------	---------	----	--------------

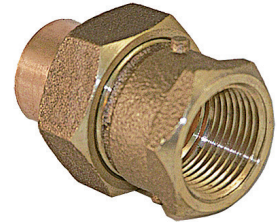

UNION			
--------------	--	--	--

37934	1/2 in.	50	683264379343
-------	---------	----	--------------

37937	3/4 in.	25	683264379374
-------	---------	----	--------------

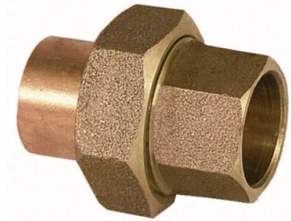

CPVC FITTINGS

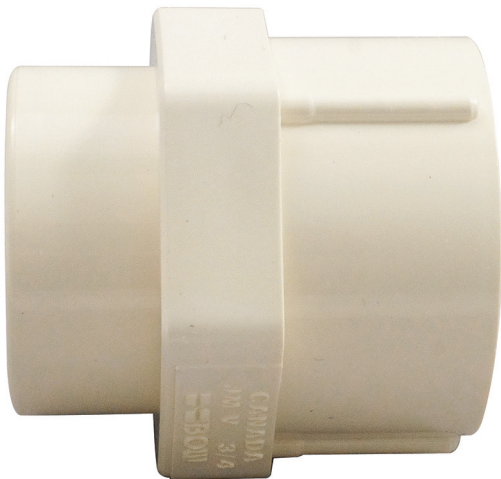

LASCO Fittings manufactures CPVC/CTS fittings to strict industry standards with a reputation for quality product, innovation, and technical leadership.

Customers of LASCO Fittings can rely upon a product used by millions of contractors worldwide. For over 50 years we have provided the products necessary to reliably transport liquids from source to application.

Features

- Fittings are produced from CPVC Type IV, Grade I.
- Do not use LASCO fittings for compressed air or gases.
- Do not test PVC piping systems with compressed air or gases.
- Do not use fittings with liquids not recommended by LASCO.
- Fitting modification voids the warranty.

Approvals

- ASTM D 1784 – Rigid Poly (Vinyl Chloride) (PVC) Compounds and Chlorinated Poly (Vinyl Chloride) (CPVC) Compounds, Class 23447-B
- ASTM D 2846 – CPVC Plastic Hot and Cold Water Distribution System
- ASTM F 493 – Solvent Cements for CPVC Pipe and Fittings
- Listed NSF/ANSI Standard 14: Plastics Piping system Components and Related Materials. Includes NSF/ANSI Standard 61, Annex G
- Listed CSA (Canadian Standards Association) B137.6

Part Number	Description	Carton Qty	UPC
45° ELBOWS			
4117005RMC	1/2 in.	50	025528785116
4117007RMC	3/4 in.	25	025528785123



90° ELBOWS			
4106005CPRMC	1/2 in. (20 Pack)	20	025528785406
4106005RMC	1/2 in.	400	025528785093
4106101RMC	3/4 in. x 1/2 in.	10	025528785086
4106007CPRMC	3/4 in. (10 Pack)	10	025528785413
4106007RMC	3/4 in.	100	025528785109
4106010RMC	1 in.	10	025528785307



45° STREET ELBOWS			
4127005RMC	1/2 in.	10	025528785376
4127007RMC	3/4 in.	10	025528785369
4127010RMC	1 in.	10	025528785291



90° STREET ELBOWS			
4109005RMC	1/2 in.	25	025528785062
4109007RMC	3/4 in.	10	025528785079



DROP EAR ELBOW			
DE4106005RMC	1/2 in. Slip	10	025528785338



CPVC



Part Number	Description	Carton Qty	UPC
STAINLESS STEEL DROP EAR ELBOW			

DE4107005RMC	1/2 in. FPT x SP	20	025528784898
--------------	------------------	----	--------------



BUSHINGS			
-----------------	--	--	--

4137101RMC	3/4 in. x 1/2 in.	50	025528785208
4137130RMC	1 in. x 1/2 in.	10	025528785246
4137131RMC	1 in. x 3/4 in.	10	025528785253



IPS TO CTS TRANSITION BUSHING			
--------------------------------------	--	--	--

4140007RMC	3/4 in.	20	025528785345
------------	---------	----	--------------



CAPS			
-------------	--	--	--

4147005RMC	1/2 in.	150	025528785178
4147007RMC	3/4 in.	50	025528785222
4147010RMC	1 in.	10	025528785260



COUPLINGS			
------------------	--	--	--

4129005CPRMC	1/2 in. (20 Pack)	20	025528785383
4129005RMC	1/2 in.	400	025528785154
4129101RMC	3/4 in. x 1/2 in.	50	025528785055
4129007CPRMC	3/4 in. (10 Pack)	15	025528785390
4129007RMC	3/4 in.	150	025528785161
4129131RMC	1 in. x 3/4 in.	10	025528785284
4129010RMC	1 in.	10	025528785277

Part Number	Description	Carton Qty	UPC
FEMALE ADAPTERS			
4135005GRMC	1/2 in.	100	025528784966
4135007GRMC	3/4 in.	50	025528784959
4135010GRMC	1 in.	10	025528784997



MALE ADAPTERS			
4136005RMC	1/2 in.	150	025528785185
4136074RMC	3/4 in. SLIP x 1/2 in. MIP	25	025528785321
4136007RMC	3/4 in.	75	025528785192
4136010RMC	1 in.	10	025528785239



TEES			
4101005CPRMC	1/2 in. (20 Pack)	20	025528785420
4101005RMC	1/2 in.	200	025528785130
4101007CPRMC	3/4 in. (10 Pack)	6	025528785437
4101007RMC	3/4 in.	75	025528785147
4101010RMC	1 in.	10	025528785314
4101094RMC	3/4 in. x 1/2 in. x 1/2 in.	10	025528785352
4101095RMC	3/4 in. x 1/2 in. x 3/4 in.	10	025528784874
4101101RMC	3/4 in. x 3/4 in. x 1/2 in.	50	025528785215
4101131RMC	1 in. x 1 in. x 3/4 in.	10	025528784881

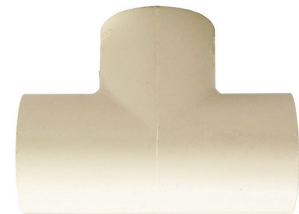

SCH 40 FITTINGS



LASCO Fittings manufactures Schedule 40 fittings to strict industry standards with a reputation for quality product, innovation, and technical leadership.

Customers of LASCO Fittings can rely upon a product used by millions of contractors worldwide. For over 50 years we have provided the products necessary to reliably transport liquids from source to application.

Features

- PVC Type 1, Cell Classification 12454-B., O-rings are produced from a Buna- N (Nitrile) material.
- Not to be used in the Hot or Cold water distribution system in a dwelling Maximum Service Temperature 140°F.
- Do not use LASCO fittings for compressed air or gases.
- Do not test PVC piping systems with compressed air or gases.
- Do not use fittings with liquids not recommended by LASCO.
- Fitting modification voids the warranty.

Approvals

- ASTM D-1784 – Rigid Poly (Vinyl Chloride) (PVC) Compounds and Chlorinated Poly Vinyl Chloride (CPVC) Compounds
- ASTM D-2466 – Socket Type Poly (Vinyl Chloride) (PVC) Plastic Pipe Fittings, Schedule 40.
- ASTM F-1970 – Standard Specification for Special Engineered Fittings, Appurtenances or Valves for use in Poly (Vinyl Chloride)(PVC) or Chlorinated Poly (Vinyl Chloride) (CPVC) systems.
- Listed NSF/ANSI Standard 61, Annex G: Drinking Water System Components Weighted average lead content of less than or equal to 0.25% and is in compliance with California's Health & Safety Code Section 116875 (commonly known as AB1953) NSF/ANSI Standard 14: Plastics Piping system components and Related Materials. Includes ANSI Standard 61, Annex G

Part Number	Description	Carton Qty	UPC
45° ELBOWS			
417005CPRMC	1/2 in. (10 Pack)	8	025528774523
417005RMC	1/2 in.	50	025528140229
417007CPRMC	3/4 in. (10 Pack)	15	025528730789
417007RMC	3/4 in.	125	025528140243
417010CPRMC	1 in. (5 Pack)	10	025528774530
417010RMC	1 in.	50	025528140267
417012RMC	1¼ in.	20	025528140281
417015RMC	1½ in.	35	025528140304
417020RMC	2 in.	20	025528140328



90° ELBOWS			
406005CPRMC	1/2 in. (10 Pack)	35	025528706418
406005LW	1/2 in. (50 Pack)	1	025528784133
406005RMC	1/2 in.	200	025528140625
406101RMC	3/4 in. x 1/2 in.	15	025528140663
406007CPRMC	3/4 in. (10 Pack)	30	025528706432
406007LW	3/4 in. (50 Pack)	1	025528784140
406007RMC	3/4 in.	300	025528140649
406010CPRMC	1 in. (5 Pack)	25	025528706456
406010LW	1 in. (50 Pack)	1	025528784157
406010RMC	1 in.	150	025528140687
406130RMC	1 in. x 1/2 in.	10	025528140724
406131RMC	1 in. x 3/4 in.	10	025528140700
406012RMC	1¼ in.	75	025528140748
406015RMC	1½ in.	60	025528140823
406167RMC	1¼ in. x 3/4 in.	10	025528706531
406168RMC	1¼ in. x 1 in.	5	025528140762
406020RMC	2 in.	35	025528140908





Part Number	Description	Carton Qty	UPC
90° STREET ELBOWS			
409005RMC	1/2 in.	25	025528142322
409007RMC	3/4 in.	15	025528142346
409010RMC	1 in.	10	025528142360
409012RMC	1¼ in.	10	025528142384
409015RMC	1½ in.	15	025528142407
409020RMC	2 in.	10	025528142421



Part Number	Description	Carton Qty	UPC
90° FEMALE ELBOWS			
407005CPRMC	1/2 in. Slip x 1/2 in. FPT (10 Pack)	20	025528761547
407005RMC	1/2 in. Slip x 1/2 in. FPT	50	025528141202
408005RMC	1/2 in. FPT x 1/2 in. FPT	25	025528142063
407074RMC	1/2 in. Slip x 3/4 in. FPT	20	025528141226
407101CPRMC	3/4 in. Slip x 1/2 in. FPT (10 Pack)	20	025528730772
407101RMC	3/4 in. Slip x 1/2 in. FPT	150	025528141264
407007RMC	3/4 in. Slip x 3/4 in. FPT	40	025528141240
408007RMC	3/4 in. FPT x 3/4 in. FPT	10	025528142087
407010RMC	1 in. Slip x 1 in. FPT	15	025528141288
407130RMC	1 in. Slip x 1/2 in. FPT	15	025528141325
407131RMC	1 in. Slip x 3/4 in. FPT	15	025528141301
407012RMC	1¼ in. Slip x 1¼ in. FPT	5	025528141349
407015RMC	1½ in. Slip x 1½ in. FPT	8	025528141400
407020RMC	2 in. Slip x 2 in. FPT	3	025528141462



Part Number	Description	Carton Qty	UPC
90° MALE/FEMALE STREET ELBOWS			
412005RMC	1/2 in.	30	025528141868
412007RMC	3/4 in.	20	025528141882
412010RMC	1 in.	10	025528141905

Part Number	Description	Carton Qty	UPC
90° MALE STREET ELBOWS			
410005RMC	1/2 in.	25	025528141660
410101RMC	3/4 in. MPT X 1/2 in. Slip	20	025528724603
410007RMC	3/4 in.	20	025528141684
410010RMC	1 in.	10	025528141707
410015RMC	1½ in.	6	025528141745
410020RMC	2 in.	3	025528141769



INSERT ADAPTERS			
474007RMC	3/4 in.	15	025528130923
474010RMC	1 in.	10	025528761653
474015RMC	1½ in.	6	025528130961



BUSHINGS			
437101RMC	3/4 in. x 1/2 in.	50	025528133047
437130RMC	1 in. x 1/2 in.	30	025528133122
437131RMC	1 in. x 3/4 in.	50	025528133108
437166RMC	1¼ in. x 1/2 in.	10	025528133207
437167RMC	1¼ in. x 3/4 in.	15	025528133184
437168RMC	1¼ in. x 1 in.	15	025528133160
437209RMC	1½ in. x 1/2 in.	10	025528133306
437210RMC	1½ in. x 3/4 in.	15	025528133283
437211RMC	1½ in. x 1 in.	12	025528133269
437212RMC	1½ in. x 1¼ in.	15	025528133245
437247RMC	2 in. x 1/2 in.	6	025528133405
437248RMC	2 in. x 3/4 in.	8	025528133382
437249RMC	2 in. x 1 in.	10	025528133368
437250RMC	2 in. x 1¼ in.	8	025528133344
437251RMC	2 in. x 1½ in.	20	025528133320





Part Number	Description	Carton Qty	UPC
FEMALE BUSHINGS			
438072BC	1/2 in. Slip x 1/4 in. FPT	100	025528134280
438098BC	3/4 in. Slip x 1/4 in. FPT	50	025528134402
438101RMC	3/4 in. Slip x 1/2 in. FPT	50	025528134365
438130RMC	1 in. Slip x 1/2 in. FPT	30	025528134488
438131RMC	1 in. Slip x 3/4 in. FPT	25	025528134464
438166RMC	1 1/4 in. Slip x 1/2 in. FPT	15	025528134587
438167RMC	1 1/4 in. Slip x 3/4 in. FPT	15	025528134563
438168RMC	1 1/4 in. Slip x 1 in. FPT	15	025528134549
438209RMC	1 1/2 in. Slip x 1/2 in. FPT	10	025528134723
438210RMC	1 1/2 in. Slip x 3/4 in. FPT	15	025528134709
438211RMC	1 1/2 in. Slip x 1 in. FPT	10	025528134686
438212RMC	1 1/2 in. Slip x 1 1/4 in. FPT	10	025528134662
438247RMC	2 in. Slip x 1/2 in. FPT	5	025528134846
438248RMC	2 in. Slip x 3/4 in. FPT	6	025528134822
438249RMC	2 in. Slip x 1 in. FPT	5	025528134808
438250RMC	2 in. Slip x 1 1/4 in. FPT	5	025528134785
438251RMC	2 in. Slip x 1 1/2 in. FPT	5	025528134761



Part Number	Description	Carton Qty	UPC
MALE/FEMALE BUSHINGS			
439101RMC	3/4 in. MPT x 1/2 in. FPT	25	025528135584
439130RMC	1 in. MPT x 1/2 in. FPT	20	025528135706
439131RMC	1 in. MPT x 3/4 in. FPT	15	025528135683
439166RMC	1 1/4 in. MPT x 1/2 in. FPT	5	025528135805
439167RMC	1 1/4 in. MPT x 3/4 in. FPT	10	025528135782
439168RMC	1 1/4 in. MPT x 1 in. FPT	10	025528135768
439210RMC	1 1/2 in. MPT x 3/4 in. FPT	10	025528135928
439211RMC	1 1/2 in. MPT x 1 in. FPT	10	025528135904
439212RMC	1 1/2 in. MPT x 1 1/4 in. FPT	10	025528135881
439251RMC	2 in. MPT x 1 1/2 in. FPT	5	025528135980

Part Number	Description	Carton Qty	UPC
CAPS			
447005CPRMC	1/2 in. (10 Pack)	15	025528774554
447005RMC	1/2 in.	150	025528136789
447007CPRMC	3/4 in. (10 Pack)	15	025528730826
447007RMC	3/4 in.	150	025528136802
447010CPRMC	1 in. (5 Pack)	15	025528774547
447010RMC	1 in.	80	025528136826
447012RMC	1¼ in.	30	025528136840
447015RMC	1½ in.	50	025528136864
447020RMC	2 in.	35	025528136888



FEMALE CAPS			
448005RMC	1/2 in.	100	025528137168
448007RMC	3/4 in.	30	025528137182
448010RMC	1 in.	20	025528137205
448012RMC	1¼ in.	10	025528137229
448015RMC	1½ in.	10	025528137243
448020RMC	2 in.	5	025528137267



COUPLINGS			
429005CPRMC	1/2 in. (10 Pack)	20	025528706883
429005LW	1/2 in. (100 Pack)	1	025528784102
429005RMC	1/2 in.	200	025528137489
429007CPRMC	3/4 in. (10 Pack)	35	025528706906
429007LW	3/4 in. (50 Pack)	1	025528784119
429007RMC	3/4 in.	350	025528137502
429010CPRMC	1 in. (10 Pack)	20	025528706920
429010LW	1 in. (50 Pack)	1	025528784126
429010RMC	1 in.	200	025528137540
429012RMC	1¼ in.	100	025528137588
429015RMC	1½ in.	100	025528137625
429020RMC	2 in.	60	025528137663





Part Number	Description	Carton Qty	UPC
FEMALE COUPLINGS			
430005RMC	1/2 in.	75	025528137946
430007RMC	3/4 in.	20	025528137960
430010RMC	1 in.	10	025528137984



CROSSES			
420005RMC	1/2 in.	15	025528139285
420007RMC	3/4 in.	15	025528139308
420010RMC	1 in.	15	025528139322
420012RMC	1¼ in.	8	025528139346
420015RMC	1½ in.	6	025528139360
420020RMC	2 in.	5	025528139384



FEMALE ADAPTERS			
435005CPRMC	1/2 in. (10 Pack)	10	025528774516
435005RMC	1/2 in.	60	025528130381
435101RMC	3/4 in. Slip x 1/2 in. FPT	30	025528130503
435007CPRMC	3/4 in. (10 Pack)	10	025528730796
435007RMC	3/4 in.	100	025528130466
435102RMC	3/4 in. Slip x 1 in. FPT	15	025528130480
435131RMC	1 in. Slip x 3/4 in. FPT	15	025528130589
435010RMC	1 in.	25	025528130527
435012RMC	1¼ in.	15	025528130626
435015RMC	1½ in.	15	025528130664
435020RMC	2 in.	10	025528130701



MALE/FEMALE RISER EXTENDERS			
434005RMC	1/2 in.	30	025528132668
434008RMC	3/4 in.	20	025528700195

Part Number	Description	Carton Qty	UPC
MALE ADAPTERS			
436005CPRMC	1/2 in. (10 Pack)	15	025528761585
436005RMC	1/2 in.	125	025528131661
436074RMC	1/2 in. x 3/4 in.	75	025528131685
436101RMC	3/4 in. x 1/2 in.	30	025528131760
436007CPRMC	3/4 in. (10 Pack)	20	025528730802
436007RMC	3/4 in.	200	025528131722
436102RMC	3/4 in. x 1 in.	30	025528131746
436131RMC	1 in. x 3/4 in.	20	025528131821
436010CPRMC	1 in. (5 Pack)	15	025528774509
436010RMC	1 in.	100	025528131784
436132RMC	1 in. x 1 1/4 in.	8	025528131807
436168RMC	1 1/4 in. x 1 in.	10	025528131883
436012RMC	1 1/4 in.	25	025528131845
436169RMC	1 1/4 in. x 1 1/2 in.	8	025528131869
436212RMC	1 1/2 in. x 1 1/4 in.	8	025528131944
436015RMC	1 1/2 in.	50	025528131906
436213RMC	1 1/2 in. x 2 in.	6	025528131920
436020RMC	2 in.	25	025528131968
436251RMC	2 in. x 1 1/2 in.	5	025528132002



MALE PLUGS			
450005RMC	1/2 in.	40	025528143145
450007RMC	3/4 in.	50	025528143169
450010RMC	1 in.	30	025528143183
450012RMC	1 1/4 in.	15	025528143206
450015RMC	1 1/2 in.	10	025528143220
450020RMC	2 in.	6	025528143244





Part Number	Description	Carton Qty	UPC
PLUGS			
449005RMC	1/2 in.	30	025528142865
449007RMC	3/4 in.	50	025528142889
449010RMC	1 in.	30	025528142902
449012RMC	1¼ in.	15	025528142926
449015RMC	1½ in.	10	025528142940
449020RMC	2 in.	5	025528142964



SIDE OUTLET ELBOWS			
413005RMC	1/2 in. Slip x Slip x Slip	35	025528779887
414005RMC	1/2 in. Slip x Slip x FPT	20	025528142704
414101RMC	3/4 in. SP x 3/4 in. SP x 1/2 in. FPT	12	025528142728
413007RMC	3/4 in. Slip x Slip x Slip	20	025528779894
414130RMC	1 in. Slip x 1 in. Slip x 1/2 in. FPT	6	025528142742
413010RMC	1 in. Slip x Slip x Slip	10	025528700171

Part Number	Description	Carton Qty	UPC
TEES			
401005CPRMC	1/2 in. (10 Pack)	25	025528706142
401005RMC	1/2 in.	150	025528145224
401007CPRMC	3/4 in. (10 Pack)	20	025528706166
401007RMC	3/4 in.	200	025528145286
401101RMC	3/4 in. x 3/4 in. x 1/2 in.	25	025528145323
401010CPRMC	1 in. (5 Pack)	20	025528706180
401010RMC	1 in.	100	025528145385
401130RMC	1 in. x 1 in. x 1/2 in.	15	025528145460
401131RMC	1 in. x 1 in. x 3/4 in.	20	025528145446
401012RMC	1 1/4 in.	40	025528145606
401166RMC	1 1/4 in. x 1 1/4 in. x 1/2 in.	5	025528145705
401167RMC	1 1/4 in. x 1 1/4 in. x 3/4 in.	5	025528145682
401168RMC	1 1/4 in. x 1 1/4 in. x 1 in.	8	025528145668
401015RMC	1 1/2 in.	35	025528145866
401209RMC	1 1/2 in. x 1 1/2 in. x 1/2 in.	6	025528145989
401210RMC	1 1/2 in. x 1 1/2 in. x 3/4 in.	6	025528145965
401211RMC	1 1/2 in. x 1 1/2 in. x 1 in.	8	025528145941
401020RMC	2 in.	25	025528146245
401247RMC	2 in. x 2 in. x 1/2 in.	5	025528146344
401248RMC	2 in. x 2 in. x 3/4 in.	5	025528146320
401249RMC	2 in. x 2 in. x 1 in.	5	025528146306
401251RMC	2 in. x 2 in. x 1 1/2 in.	5	025528146269



BULLHEAD TEES			
401074RMC	1/2 in. x 1/2 in. x 3/4 in.	10	025528145262
401102RMC	3/4 in. x 3/4 in. x 1 in.	5	025528145309





Part Number	Description	Carton Qty	UPC
FEMALE TEES			
405005RMC	1/2 in. FPT x FPT x FPT	15	025528149383
402005CPRMC	1/2 in. Slip x Slip x FPT (10 Pack)	20	025528761554
402005RMC	1/2 in. Slip x Slip x FPT	35	025528147426
405007RMC	3/4 in. FPT x FPT x FPT	10	025528149406
403007RMC	3/4 in. Slip x FPT x Slip	20	025528149369
402007RMC	3/4 in. Slip x Slip x FPT	25	025528147488
402101CPRMC	3/4 in. SP x 3/4 SP x 1/2 in. FPT (10 Pack)	20	025528730765
402101RMC	3/4 in. SP x 3/4 in. SP x 1/2 in. FPT	100	025528147525
405010RMC	1 in. FPT x FPT x FPT	10	025528149420
402010RMC	1 in. Slip x Slip x FPT	10	025528147587
402130RMC	1 in. SP x 1 in. SP x 1/2 in. FPT	25	025528147662
402131RMC	1 in. SP x 1 in. SP x 3/4 in. FPT	15	025528147648
402012RMC	1 1/4 in. Slip x Slip x FPT	5	025528147808
402166RMC	1 1/4 in. SP x 1 1/4 in. SP x 1/2 in. FPT	5	025528147907
402167RMC	1 1/4 in. SP x 1 1/4 in. SP x 3/4 in. FPT	5	025528147884
405015RMC	1 1/2 in. FPT x FPT x FPT	6	025528149468
402015RMC	1 1/2 in. Slip x Slip x FPT	6	025528148065
402209RMC	1 1/2 in. SP x 1 1/2 in. SP x 1/2 in. FPT	25	025528148140
402210RMC	1 1/2 in. SP x 1 1/2 in. SP x 3/4 in. FPT	5	025528148126
402211RMC	1 1/2 in. SP x 1 1/2 in. SP x 1 in. FPT	6	025528148102
402020RMC	2 in. Slip x Slip x FPT	5	025528148409
402247RMC	2 in. SP x 2 in. SP x 1/2 in. FPT	5	025528148508
402248RMC	2 in. SP x 2 in. SP x 3/4 in. FPT	5	025528148485
402249RMC	2 in. SP x 2 in. SP x 1 in. FPT	5	025528148461

Part Number	Description	Carton Qty	UPC
SNAP-ON TEES			
464007RMC	3/4 in. Snap-On x FPT	10	025528761707
464101RMC	3/4 in. x 1/2 in. FPT	10	025528761714
464130RMC	1 in. x 1/2 in. FPT	10	025528761721
464131RMC	1 in. x 3/4 in. FPT	8	025528761738



UNIONS			
457005RMC	1/2 in.	10	025528149642
457007RMC	3/4 in.	10	025528149666
457010RMC	1 in.	10	025528149680
457012RMC	1¼ in.	6	025528149703
457015RMC	1½ in.	6	025528149727
457020RMC	2 in.	4	025528149741



FEMALE UNIONS			
458005RMC	1/2 in.	10	025528149840
458007RMC	3/4 in.	10	025528149864
458010RMC	1 in.	10	025528149888
458012RMC	1¼ in.	5	025528730857
458015RMC	1½ in.	5	025528149925
458020RMC	2 in.	5	025528149949



SCH 80 FITTINGS



LASCO Fittings manufactures Schedule 80 fittings to strict industry standards with a reputation for quality product, innovation, and technical leadership.

Customers of LASCO Fittings can rely upon a product used by millions of contractors worldwide. For over 50 years we have provided the products necessary to reliably transport liquids from source to application.

Features

- Do not use LASCO fittings for compressed air or gases.
- Do not test PVC piping systems with compressed air or gases.
- Do not use fittings with liquids not recommended by LASCO.
- Fitting modification voids the warranty.

Approvals

- ASTM D-1784 – Rigid Poly (Vinyl Chloride) (PVC) Compounds and Chlorinated Poly Vinyl Chloride (CPVC) Compounds
- ASTM D-2464 – Threaded Poly (Vinyl Chloride) (PVC) Plastic Pipe Fittings, Schedule 80.
- ASTM D-2467 – Socket Type Poly (Vinyl Chloride) (PVC) Plastic Pipe Fittings, Schedule 80.
- LISTINGS – NSF/ANSI Standard 61, Annex G: Drinking Water System Components Weighted average lead content of less than or equal to 0.25% and is in compliance with California's Health & Safety Code Section 116875 (commonly known as AB1953) NSF/ANSI Standard 14: Plastics Piping system components and Related Materials. Includes ANSI Standard 61, Annex G

Part Number	Description	Carton Qty	UPC
45° ELBOWS			
817005RMC	1/2 in.	15	025528161880
817007RMC	3/4 in.	20	025528161903
817010RMC	1 in.	15	025528161927



45° FEMALE ELBOWS			
819005RMC	1/2 in. FPT x FPT	20	025528162283
819007RMC	3/4 in. FPT x FPT	10	025528162306



90° ELBOWS			
806005RMC	1/2 in.	20	025528162702
806007RMC	3/4 in.	25	025528162726
806010RMC	1 in.	10	025528162764
806012RMC	1 1/4 in.	5	025528162825



90° FEMALE ELBOWS			
807005RMC	1/2 in. Slip x FPT	15	025528163280
808005RMC	1/2 in. FPT x FPT	15	025528163549
807007RMC	3/4 in. Slip x FPT	15	025528163303
808007RMC	3/4 in. FPT x FPT	15	025528163563
807010RMC	1 in. Slip x FPT	10	025528163327
808010RMC	1 in. FPT x FPT	10	025528163587
808012RMC	1 1/4 in. FPT x FPT	5	025528163600



FLANGES (Solid Style)			
852005RMC	1/2 in. FPT	15	025528164102
852007RMC	3/4 in. FPT	10	025528164126
852010RMC	1 in. FPT	10	025528164140
852012RMC	1 1/4 in. FPT	6	025528164164





Part Number	Description	Carton Qty	UPC
BUSHINGS			
837101RMC	3/4 in. x 1/2 in.	20	025528156626
837130RMC	1 in. x 1/2 in.	20	025528156701
837131RMC	1 in. x 3/4 in.	20	025528156688
837168RMC	1 1/4 in. x 1 in.	10	025528156749



FEMALE BUSHINGS			
838101RMC	3/4 in. Slip x 1/2 in. FPT	20	025528157807
838130RMC	1 in. Slip x 1/2 in. FPT	20	025528157883
838131RMC	1 in. Slip x 3/4 in. FPT	20	025528157869
838167RMC	1 1/4 in. Slip 3/4 in. FPT	10	025528157944
838168RMC	1 1/4 in. Slip x 1 in. FPT	10	025528157920



MALE/FEMALE BUSHINGS			
839072RMC	1/2 in. MPT x 1/4 in. FPT	20	025528158828
839073RMC	1/2 in. MPT x 3/8 in. FPT	20	025528158804
839098RMC	3/4 in. MPT x 1/4 in. FPT	20	025528158880
839099RMC	3/4 in. MPT x 3/8 in. FPT	20	025528158866
839101RMC	3/4 in. MPT x 1/2 in. FPT	25	025528158842
839130RMC	1 in. MPT x 1/2 in. FPT	20	025528158927
839131RMC	1 in. MPT x 3/4 in. FPT	20	025528158903
839166RMC	1 1/4 in. MPT x 1/2 in. FPT	15	025528159023
839167RMC	1 1/4 in. MPT x 3/4 in. FPT	15	025528159009
839168RMC	1 1/4 in. MPT x 1 in. FPT	15	025528158989



CAPS			
847005RMC	1/2 in.	30	025528159900
847007RMC	3/4 in.	20	025528159924
847010RMC	1 in.	15	025528159948
847012RMC	1 1/4 in.	10	025528159962

Part Number	Description	Carton Qty	UPC
FEMALE CAPS			
848005RMC	1/2 in.	30	025528160302
848007RMC	3/4 in.	20	025528160326
848010RMC	1 in.	15	025528160340
848012RMC	1¼ in.	10	025528160364



COUPLINGS			
829005RMC	1/2 in.	30	025528160647
829007RMC	3/4 in.	20	025528160661
829010RMC	1 in.	15	025528160708
829012RMC	1¼ in.	10	025528160746



FEMALE COUPLINGS			
830005RMC	1/2 in. FPT x FPT	20	025528161149
830007RMC	3/4 in. FPT x FPT	10	025528161163
830010RMC	1 in. FPT x FPT	15	025528161187
830012RMC	1¼ in. FPT x FPT	10	025528161200



FEMALE ADAPTERS			
835005RMC	1/2 in. Slip x FPT	15	025528155025
835007RMC	3/4 in. Slip x FPT	15	025528155100
835010RMC	1 in. Slip x FPT	15	025528155162
835012RMC	1¼ in. Slip x FPT	10	025528155261



MALE ADAPTERS			
836005RMC	1/2 in. Slip x MPT	30	025528155940
836007RMC	3/4 in. Slip x MPT	20	025528156008
836010RMC	1 in. Slip x MPT	20	025528156060
836012RMC	1¼ in. Slip x MPT	10	025528156121





Part Number	Description	Carton Qty	UPC
PIPE NIPPLES (Threaded both ends)			
205011RMC	1/2 in. x CLOSE	50	025528118129
205020RMC	1/2 in. x 2 in.	40	025528118143
205025RMC	1/2 in. x 2½ in.	25	025528118150
205030RMC	1/2 in. x 3 in.	25	025528118167
205040RMC	1/2 in. x 4 in.	25	025528118181
205050RMC	1/2 in. x 5 in.	20	025528118204
205060RMC	1/2 in. x 6 in.	20	025528118228
205080RMC	1/2 in. x 8 in.	20	025528118242
205100RMC	1/2 in. x 10 in.	20	025528118266
205120RMC	1/2 in. x 12 in.	20	025528118280
207013RMC	3/4 in. x CLOSE	40	025528118471
207020RMC	3/4 in. x 2 in.	40	025528118495
207030RMC	3/4 in. x 3 in.	25	025528118518
207040RMC	3/4 in. x 4 in.	25	025528118532
207050RMC	3/4 in. x 5 in.	20	025528118556
207060RMC	3/4 in. x 6 in.	20	025528118570
207080RMC	3/4 in. x 8 in.	10	025528118594
207100RMC	3/4 in. x 10 in.	10	025528118617
207120RMC	3/4 in. x 12 in.	10	025528118679
210015RMC	1 in. x CLOSE	15	025528118952
210020RMC	1 in. x 2 in.	15	025528118969
210030RMC	1 in. x 3 in.	10	025528118983
210040RMC	1 in. x 4 in.	10	025528119003
210050RMC	1 in. x 5 in.	15	025528119027
210060RMC	1 in. x 6 in.	10	025528119041
210080RMC	1 in. x 8 in.	10	025528119065
210100RMC	1 in. x 10 in.	10	025528119089
210120RMC	1 in. x 12 in.	10	025528119102
212016RMC	1¼ in. x CLOSE	20	025528119294
212020RMC	1¼ in. x 2 in.	10	025528119300
212030RMC	1¼ in. x 3 in.	10	025528119324
212040RMC	1¼ in. x 4 in.	10	025528119348
212050RMC	1¼ in. x 5 in.	5	025528119362
212060RMC	1¼ in. x 6 in.	5	025528119386
212080RMC	1¼ in. x 8 in.	5	025528119409
212100RMC	1¼ in. x 10 in.	5	025528119423
212120RMC	1¼ in. x 12 in.	5	025528119447
215030BC	1½ in. x 3 in.	25	025528119669
220030BC	2 in. x 3 in.	10	025528120009

Part Number	Description	Carton Qty	UPC
MALE PLUGS			
850005RMC	1/2 in.	30	025528165802
850007RMC	3/4 in.	30	025528165826
850010RMC	1 in.	20	025528165840
850012RMC	1¼ in.	15	025528165864



TEES			
801005RMC	1/2 in.	15	025528166120
801101RMC	3/4 in. x 3/4 in. x 1/2 in.	15	025528166229
801007RMC	3/4 in.	15	025528166182
801010RMC	1 in.	10	025528166281
801012RMC	1¼ in.	5	025528166502



FEMALE TEES			
805005RMC	1/2 in. FPT x FPT x FPT	20	025528170301
802005RMC	1/2 in. Slip x Slip X FPT	20	025528168308
805007RMC	3/4 in. FPT x FPT x FPT	15	025528168308
802007RMC	3/4 in. Slip x Slip x FPT	10	025528168360
805010RMC	1 in. FPT x FPT x FPT	10	025528170349
805012RMC	1¼ in. FPT x FPT x FPT	5	025528170363



INSERT FITTINGS



LASCO Fittings manufactures Insert fittings to strict industry standards with a reputation for quality product, innovation, and technical leadership.

Customers of LASCO Fittings can rely upon a product used by millions of contractors worldwide. For over 50 years we have provided the products necessary to reliably transport liquids from source to application.

Features

- For COLD Water Only - Do Not Use In a Dwelling.
- PVC Type 1, Cell Classification 12454-B.
- Do not use LASCO fittings for compressed air or gases.
- Do not test PVC piping systems with compressed air or gases.
- Do not use fittings with liquids not recommended by LASCO.
- Fitting modification voids the warranty.

Approvals

- Listed NSF 14 and 61 (National Sanitation Foundation) for potable water services.
- ASTM D-2609 – Plastic Insert Fittings for Polyethylene (PE) Plastic Pipe.
- ASTM D-1784 – Rigid Poly (Vinyl Chloride) (PVC) Compounds and Chlorinated Poly (Vinyl Chloride) (CPVC) Compounds.

Part Number	Description	Carton Qty	UPC
COUPLINGS			
L1429005RMC	1/2 in.	50	025528105426
L1429101RMC	3/4 in. x 1/2 in.	25	025528105594
L1429007CPRMC	3/4 in. (10 Pack)	10	025528791490
L1429007RMC	3/4 in.	75	025528105433
L1429010CPRMC	1 in. (10 Pack)	6	025528791506
L1429010RMC	1 in.	50	025528105457
L1429130RMC	1 in. x 1/2 in.	10	025528105600
L1429131RMC	1 in. x 3/4 in.	20	025528105617
L1429012RMC	1 1/4 in.	20	025528105464
L1429167RMC	1 1/4 in. x 3/4 in.	5	025528105624
L1429168RMC	1 1/4 in. x 1 in.	10	025528105631
L1429015RMC	1 1/2 in.	10	025528105471
L1429212RMC	1 1/2 in. x 1 1/4 in.	5	025528105662
L1429020RMC	2 in.	5	025528105488
L1429251RMC	2 in. x 1 1/2 in.	5	025528105693



ELBOWS			
L1406005RMC	1/2 in.	25	025528105747
L1406007RMC	3/4 in.	50	025528105754
L1406010RMC	1 in.	25	025528105761
L1406012RMC	1 1/4 in.	10	025528105778
L1406015RMC	1 1/2 in.	10	025528105785
L1406020RMC	2 in.	5	025528105792



MALE ELBOWS			
L1413005RMC	1/2 in.	25	025528106119
L1413007RMC	3/4 in.	15	025528106126
L1413010RMC	1 in.	10	025528106133
L1413012RMC	1 1/4 in.	5	025528106140





Part Number	Description	Carton Qty	UPC
FEMALE ELBOWS			
L1407005RMC	1/2 in.	25	025528105952
L1407101RMC	3/4 in. x 1/2 in.	25	025528105969
L1407007RMC	3/4 in.	25	025528105976
L1407010RMC	1 in.	15	025528106003
L1407130RMC	1 in. x 1/2 in.	10	025528105983
L1407131RMC	1 in. x 3/4 in.	20	025528105990
L1407012RMC	1 1/4 in.	5	025528106041



Part Number	Description	Carton Qty	UPC
FEMALE ADAPTERS			
L1435005RMC	1/2 in.	25	025528105006
L1435007RMC	3/4 in.	25	025528105013
L1435010RMC	1 in.	25	025528105020
L1435012RMC	1 1/4 in.	10	025528105037



Part Number	Description	Carton Qty	UPC
MALE ADAPTERS			
L1436005RMC	1/2 in.	50	025528105075
L1436101RMC	1/2 in. Insert x 3/4 in. MPT	25	025528105341
L1436074RMC	3/4 in. Insert x 1/2 in. MPT	50	025528724542
L1436007RMC	3/4 in.	75	025528105082
L1436102RMC	3/4 in. Insert x 1 in. MPT	25	025528105280
L1436131RMC	1 in. Insert x 3/4 in. MPT	15	025528105358
L1436010RMC	1 in.	50	025528105099
L1436012RMC	1 1/4 in.	20	025528105105
L1436167RMC	1 1/4 in. Insert x 3/4 in. MPT	10	025528105365
L1436168RMC	1 1/4 in. Insert x 1 in. MPT	10	025528105372
L1436169RMC	1 1/4 in. Insert x 1 1/2 in. MPT	5	025528105310
L1436015RMC	1 1/2 in.	15	025528105112
L1436212RMC	1 1/2 in. Insert x 1 1/4 in. MPT	10	025528105396
L1436020RMC	2 in.	5	025528105129

Part Number	Description	Carton Qty	UPC
PLUGS			
L1449005RMC	1/2 in.	40	025528106263
L1449007RMC	3/4 in.	25	025528106270
L1449010RMC	1 in.	15	025528106287



TEES			
L1401005RMC	1/2 in.	25	025528106331
L1401101RMC	3/4 in. x 3/4 in. x 1/2 in.	25	025528106485
L1401007RMC	3/4 in.	25	025528106348
L1401010RMC	1 in.	15	025528106355
L1401012RMC	1 1/4 in.	10	025528106362
L1401015RMC	1 1/2 in.	5	025528106379
L1401020RMC	2 in.	5	025528106386



FEMALE TEES			
L1402005RMC	1/2 in.	25	025528106782
L1402101RMC	3/4 in. Insert x 3/4 in. Insert x 1/2 in. FPT	25	025528106799
L1402007RMC	3/4 in.	25	025528106805
L1402010RMC	1 in.	10	025528106836
L1402130RMC	1 in. Insert x 1 in. Insert x 1/2 in. FPT	15	025528106812
L1402131RMC	1 in. Insert x 1 in. Insert x 3/4 in. FPT	10	025528106829
L1402166RMC	1 1/4 in. Insert x 1 1/4 in. Insert x 1/2 in. FPT	5	025528106843
L1402167RMC	1 1/4 in. Insert x 1 1/4 in. Insert x 3/4 in. FPT	5	025528106850
L1402168RMC	1 1/4 in. Insert x 1 1/4 in. Insert x 1 in. FPT	5	025528106867



SCH 40 PUSH



LASCO Fittings manufactures Schedule 40 Push fittings to strict industry standards with a reputation for quality product, innovation, and technical leadership.

Customers of LASCO Fittings can rely upon a product used by millions of contractors worldwide. For over 50 years we have provided the products necessary to reliably transport liquids from source to application.

Features

- No glue, no primer, no waiting.
- Can be used on mainlines and can install wet.
- For irrigation use only.
- Do not use in a dwelling.
- Must be buried.
- Do not use LASCO fittings for compressed air or gases.
- Do not test PVC piping systems with compressed air or gases.
- Do not use fittings with liquids not recommended by LASCO.
- Fitting modification voids the warranty.

Part Number	Description	Carton Qty	UPC
CAPS			
LPC47005RMC	1/2 in.	10	025528794446
LPC47007RMC	3/4 in.	10	025528794453
LPC47010RMC	1 in.	10	025528794460



COUPLINGS			
LPC29005RMC	1/2 in.	10	025528794354
LPC29007RMC	3/4 in.	10	025528794361
LPC29010RMC	1 in.	10	025528794378



90° ELBOWS			
LPC06005RMC	1/2 in.	10	025528794385
LPC06007RMC	3/4 in.	10	025528794392
LPC06010RMC	1 in.	10	025528794408



REPAIR COUPLINGS			
LPC2918005RMC	1/2 in.	10	025528794477
LPC2918007RMC	3/4 in.	10	025528794484
LPC2918010RMC	1 in.	10	025528794491



TEES			
LPC01005RMC	1/2 in.	10	025528794415
LPC01007RMC	3/4 in.	10	025528794422
LPC01010RMC	1 in.	10	025528794439



REMOVAL TOOLS			
LPRT005RMC	1/2 in.	20	025528794507
LPRT007RMC	3/4 in.	20	025528794514
LPRT010RMC	1 in.	20	025528794521



SPRINT & FLEXI-ADAPTERS

SPRINT
by "Apollo"



Flexi-Adapters



Sprint fittings are push to connect fittings for Polyethylene pipe in irrigation applications. They are removeable and reusable, making installation very easy.

Flexi-Adapter - one fitting, all pipes. The design of the Flexi-Adapter by Apollo® ensures that the pipe enters the adapter easily, avoiding the need for a high push-in force. There is no need to chamfer the pipe prior to installation.

As you tighten the nut, the plastic teeth and steel nails in the compression cartridge will grip the pipe and compress the o-ring against the pipe ensuring a leak-free seal under all pressure conditions.

The plastic teeth will grip on all soft materials like polyethylene pipe (PE), PEX, and even lead. The steel nails will grip on all harder materials like very hard plastics and metals.

Sprint Features

- 100% corrosion resistant.
- No special tools needed for installation.
- Approved for burial.
- Install regardless of temperature or weather
- Removeable and reusable.

Flexi-Adapter Features

- 1/2 in. galvanized pipe, PVC, black iron, and PP-R can be used with Flex-Adapters.
- 3/4 in. galvanized pipe, PVC, black iron, PP-R, Copper, PEX, and CPVC can be used with Flexi-Adapters.
- Suitable for burial.
- Can be used with water, seawater, and vacuum applications.
- Material is environmentally friendly and 100% corrosion resistant.

Part Number	Description	Carton Qty	UPC
SPRINT			

SPRC34	3/4 in. Coupling	8	670750849626
--------	------------------	---	--------------



SPRCAP34	3/4 in. Cap	8	670750849862
----------	-------------	---	--------------



SPRE34	3/4 in. Elbow	5	670750849664
--------	---------------	---	--------------



SPRMA34	3/4 in. Male Adapter	8	670750849640
---------	----------------------	---	--------------



SPRT34	3/4 in. Tee	5	670750849800
--------	-------------	---	--------------



FLEXI-ADAPTERS			
-----------------------	--	--	--

SPRFLX123434	1/2 in. or 3/4 in. x 3/4 in. MNPT	8	670750855801
--------------	-----------------------------------	---	--------------



SPRFLX12341	1/2 in. or 3/4 in. x 1 in. MNPT	8	670750855740
-------------	---------------------------------	---	--------------

BLUE TWISTERS

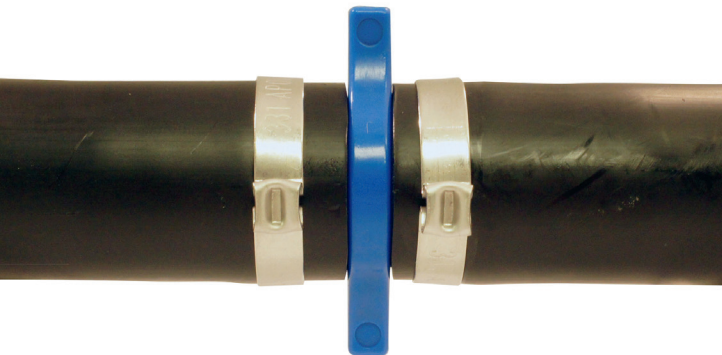

The self-threading Double Helix® design of Blue Twister® irrigation fittings provides effortless insertion into Polyethylene (PE) pipe. No longer is there a need to hammer or walk them into the pipe. Just twist the fitting clockwise into the pipe and let the Double Helix® pull the pipe onto the fitting.

Once the pipe has covered all of the barbs you are assured a connection that does not leak and will withstand the water pressure of your installation.

FEATURES

- Easy installation without tools.
- 100% corrosion resistant.
- Suitable for underground applications.
- No restriction on number of connections.

SPECIFICATIONS

- 160 psi @ 73° F
- Made from polypropylene plastic.
- For use with Polyethylene (PE) pipe.
- For use with cold water applications only.

APPROVALS

- ASTM D-2609
- NSF 61 for potable water
- ANSI/NSF 14 & 7

Part Number	Description	Carton Qty	UPC
COUPLINGS			
ABTC12	1/2 in.	50	670750847998
ABTC125PK	1/2 in. (5 Pack)	10	670750848001
ABTC3412	3/4 in. x 1/2 in.	25	670750848049
ABTC34	3/4 in.	75	670750848032
ABTC345PK	3/4 in. (5 Pack)	15	670750848056
ABTC134	1 in. x 3/4 in.	20	670750848018
ABTC1	1 in.	50	670750847837
ABTC15PK	1 in. (5 Pack)	10	670750848025
ABTC1114	1 1/4 in. x 1 in.	10	670750847950
ABTC114	1 1/4 in.	20	670750847981
ABTC112	1 1/2 in.	10	670750847974



ELBOWS			
ABTE12	1/2 in.	25	670750848094
ABTE34	3/4 in.	25	670750848100
ABTE1	1 in.	25	670750848063
ABTE114	1 1/4 in.	10	670750848087
ABTE112	1 1/2 in.	10	670750848070
ABTFE12	1/2 in. x 1/2 in. FPT	25	670750848186
ABTFE1234	3/4 in. x 1/2 in. FPT	25	670750848193
ABTFE34	3/4 in. x 3/4 in. FPT	25	670750848216
ABTFE112	1 in. x 1/2 in. FPT	10	670750848179
ABTFE134	1 in. x 3/4 in. FPT	20	670750848209
ABTFE1	1 in. x 1 in. FPT	15	670750848162
ABTME12	1/2 in. x 1/2 in. MPT	25	670750848544
ABTME34	3/4 in. x 3/4 in. MPT	15	670750848551
ABTME1	1 in. x 1 in. MPT	10	670750848537



FEMALE ADAPTERS			
ABTFA12	1/2" Insert x FPT	25	670750848148
ABTFA34	3/4" Insert x FPT	25	670750848155
ABTFA1	1" Insert x FPT	25	670750848117
ABTFA114	1 1/4" Insert x FPT	10	670750848131
ABTFA112	1 1/2" Insert x FPT	15	670750848124

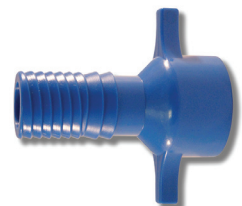



Part Number	Description	Carton Qty	UPC
MALE ADAPTERS			
ABTMA12	1/2 in. x 1/2 in. MPT	50	670750848452
ABTMA125PK	1/2 in. x 1/2 in. MPT (5 Pack)	10	670750848476
ABTMA1234	1/2 in. x 3/4 in. MPT	25	670750848469
ABTMA3412	3/4 in. x 1/2 in. MPT	25	670750848513
ABTMA34	3/4 in. x 3/4 in. MPT	75	670750848490
ABTMA345PK	3/4 in. x 3/4 in. MPT (5 Pack)	15	670750848520
ABTMA341	3/4 in. x 1 in. MPT	15	670750848506
ABTMA134	1 in. x 3/4 in. MPT	15	670750848483
ABTMA1	1 in. x 1 in. MPT	50	670750848421
ABTMA15PK	1 in. x 1 in. MPT (5 Pack)	10	670750855719
ABTMA114	1 1/4 in. x 1 1/4 in. MPT	20	670750848445
ABTMA112	1 1/2 in. x 1 1/2 in. MPT	15	670750848438



TEES			
ABTT12	1/2 in.	25	670750848957
ABTT34	3/4 in.	25	670750849015
ABTT1	1 in.	15	670750848612
ABTT114	1 1/4 in.	10	670750848940
ABTT112	1 1/2 in.	5	670750848933
ABTFT12	1/2 in. x 1/2 in. x 1/2 in. FPT	25	670750848261
ABTFT343412	3/4 in. x 3/4 in. x 1/2 in. FPT	25	670750848414
ABTFT34	3/4 in. x 3/4 in. x 3/4 in. FPT	25	670750848407
ABTFT1112	1 in. x 1 in. x 1/2 in. FPT	15	670750848223
ABTFT1134	1 in. x 1 in. x 3/4 in. FPT	10	670750848230

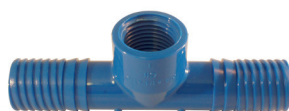

PLUGS			
ABTP12	1/2 in.	40	670750848599
ABTP34	3/4 in.	25	670750848605
ABTP1	1 in.	15	670750848568
ABTP114	1 1/4 in.	10	670750848582
ABTP112	1 1/2 in.	10	670750848575



Subject to the conditions and limitations in this Limited Warranty, Conbraco Industries, Inc. (Conbraco) warrants to the owner of applicable real property in the United States (including its territories) and Canada that Apollo products, when properly installed in potable water piping systems and hydronic heating piping systems, under normal conditions of use, shall be free from failure caused by manufacturing defects for the applicable Warranty Period. This Limited Warranty is in effect for installations made after January 1, 2017 and applies strictly to products installed in the country which they were purchased.

Validation of the Warranty Period is required through proof of purchase. In the event that proof of purchase is unavailable, the Warranty Period initiation date shall default to the date of manufacture for each product. If the product suspected of a defect does not have a visible date of manufacture, a proof of purchase shall be required.

All products must be installed in accordance with all then applicable codes, good plumbing practice, in accordance with any local, state, provincial or federal requirements, and installed in a potable water or radiant heating application unless a non-potable water service is specifically described in published pertinent product literature.

The installer must use construction techniques compliant with then applicable codes to install the product and use the product within the design parameters specified in any installation guidelines and technical notes for the applicable system. This shall include field pressure testing prior to concealing with concrete or by other means and wrapping any brass fitting when buried. Failure to install Apollo products according to manufacturer's installation instructions will void all applicable warranties and may result in severe water damage.

Products must at all times be used in a manner consistent with their intended use and be used in installations and environments acceptable to their material and design specifications, including not being installed in a system that may operate at temperatures or at pressures that exceed the approved ratings which can be found on the product, packaging or installation instructions.

Product specific conditions of this Limited Warranty and the Warranty Period are detailed in the table entitled "Additional Product Specific Warranty Information".

Without limiting the foregoing, this Limited Warranty does not apply and you do not have a right of reimbursement if the product failure or resulting damage is caused by: (a) evidence of tampering, mishandling, neglect, abuse, accidental damage, freeze damage (it is expressly understood that failure as a result of any freezing fluids within the pipes does not constitute a defect in material or workmanship and shall not be covered by this warranty) or unauthorized modifications or repairs that cause damage to warranted products; (b) exposure to harmful, unauthorized, or unanticipated chemicals or substances or corrosive water conditions; (c) exposure to ultraviolet light; (d) faulty installation including failure to follow proper burial instructions; (e) damage from abnormal operating conditions including exposure pressures and temperatures beyond the specified operating range; (f) failure to properly test and pass common testing methods (including pressure testing) after the installation and before the product or system is put in service; (g) components not manufactured or sold by Conbraco Industries; or (h) acts of nature such as earthquakes, re, flood or lightning.

Although Conbraco Industries provides a plumbing system to facilitate a complete installation, other manufacturers pipe and/or fittings may be installed in any given installation provided manufacturing of the pipe and/or fittings demonstrates compliance with the applicable ASTM/CSA standards, and the product has been certified by a recognized third-party testing agency. The Conbraco Industries product in the given installation will continue to be covered under this Limited Warranty although limits on Warranty Period may apply. Conbraco Industries will be responsible only for proven defects in material or workmanship in Conbraco Industries products. Problems in products manufactured by another company should be reported to that manufacturer.

In order to be eligible for service under this Limited Warranty, it is the responsibility of the property owner to obtain and pay for repairs. Only if the warranty applies will Conbraco be responsible for reimbursement under this warranty. The part or parts which you claim failed should be kept and Conbraco contacted at the address below or by telephoning within thirty (30) days after the failure or leak and identifying yourself as having a warranty claim. You should be prepared to ship, at your expense, the product which you claim failed due to a manufacturing defect (including the original section of pipe still inserted), document the date of installation, proof of purchase, and the amount of any claimed bills for which you seek reimbursement. Products returned without shipping charges prepaid will be refused. Within a reasonable time after receiving the product, Conbraco will investigate the reasons for the failure, which includes the right to inspect the product at Conbraco and reasonable access to the site of damage in order to determine whether the warranty applies. Conbraco will notify you of the results of this review. For questions or inquiries, call 1(888)229-2874.

In the event that Conbraco Industries, Inc. determines that the failure or leak and any resulting damages were the result of a manufacturing defect in the products covered by limited warranties outlined below, Conbraco will reimburse the property owner for reasonable repair or replacement charges to include drywall, flooring and painting costs, as well as damages to personal property, resulting from the failure or leak. Except as specified above or otherwise specifically authorized in writing by Conbraco Industries, Conbraco Industries shall not pay for any costs or expenses for transportation, relocation, labor, repairs or any other work associated with removing and/or returning failed or defective products or installing replacement products. Any change in property ownership after the first ten years will nullify any remaining warranty coverage. This shall constitute the sole and exclusive remedy for any defective product.

Conbraco Industries shall not be responsible for any other incidental, indirect, contingent, special or consequential damages, including without limitation, economic loss, lost profits or the cost of repairing or replacing other property which is damaged if these warranted products do not work properly, other costs resulting from labor charges, delays, vandalism, negligence, fouling caused by foreign material, damage from adverse water conditions, adverse chemical environments, or any other circumstances over which Conbraco Industries has no control. This limitation applies even if Conbraco Industries could have foreseen or has been advised of the possibility of these damages. This Limited Warranty shall be invalidated by any abuse, misuse, misapplication or improper installation of the product. Any remaining warranty coverage may not be assigned or transferred after the period ending ten years following the installation. Conbraco Industries does not guarantee or in any way warrant the integrity or workmanship of the contractor/installer.

Other than this limited warranty, Conbraco Industries, Inc. does not authorize any person or firm to create for it any other obligation or liability in connection with its products. This written warranty applies for the first 10 years of the applicable warranty regardless of any change of ownership in the property. Some states do not allow the exclusion or limitation of incidental or consequential damages or limitations on the duration of implied warranties in certain types of transactions, so the above exclusion or limitations may not apply to you.

LIMITATION OF LIABILITY: Conbraco Industries, Inc. SHALL NOT UNDER ANY CIRCUMSTANCES BE LIABLE FOR SPECIAL OR CONSEQUENTIAL DAMAGES SUCH AS, BUT NOT LIMITED TO, DAMAGES OR TO LOSS OF OTHER PROPERTY OR EQUIPMENT, LOSS OF PROFITS OR REVENUE, COST OF CAPITAL, COST OF PURCHASED OR REPLACEMENT GOODS, OR CLAIMS OF CUSTOMERS OF OUR INITIAL PURCHASER. THE REMEDIES OF OUR INITIAL PURCHASER, AND ALL OTHERS, SET FORTH HEREIN, ARE EXCLUSIVE, AND THE LIABILITY OF CONBRACO WITH RESPECT TO SAME SHALL NOT, EXCEPT AS EXPRESSLY PROVIDED HEREIN, EXCEED THE PRICE OF THE GOODS UPON WHICH SUCH LIABILITY IS BASED.

This Limited Warranty and any claims arising from breach of contract, breach of warranty, tort, or any other claim arising from sale or use of Conbraco Industries products shall be governed and construed under the laws of the State of North Carolina. No action on the part of Conbraco Industries under this Limited Warranty shall be construed as an admission of liability of that the product is not for its intended use.

ADDITIONAL PRODUCT SPECIFIC WARRANTY INFORMATION

Product Group	Limited Warranty Period	Conditions
Tectite™ by Apollo® Push-To-Connect Fittings	Lifetime	For exclusive use with: PEX - ASTM F876/CSA B137.5 Copper - ASTM B 88 hard drawn copper tube K, L, & M CPVC - ASTM D2846 or CSA B137.6 PE-RT - ASTM F2769
Tectite™ by Apollo® Push-To-Connect Fittings in HDPE Applications	5 Years	For exclusive use with HDPE SDR-9 ASTM D2737.
Tectite™ by Apollo® Tools	5 Years	From date of purchase and when used in accordance with instructions.
Tectite™ by Apollo® Valves	5 Years	Must be installed per published installation instructions.
Tectite™ by Apollo® Accessories (Connectors, supply stops, appliance outlet boxes, kits, manifolds, hoses, etc.)	5 Years	Must be installed per published installation instructions.
Apollo® PEX Brass Fittings & Copper Manifolds (PEXb)	25 Years	For exclusive use with: PEX - ASTM F876/CSA B137.5 Copper Crimp Rings - ASTM F1807 Stainless Steel Pinch Clamps & Sleeves - ASTM F2098
Apollo® PEX Poly Alloy Fittings (PEXb)	25 Years	For exclusive use with: PEX - ASTM F876/CSA B137.5 Copper Crimp Rings - ASTM 2159 Stainless Steel Pinch Clamps & Sleeves - ASTM F2098
Apollo® Expansion PEX Fittings (PEXa)	25 Years	For exclusive use with PEXa pipe.
Apollo® Expansion PEX Pipe (PEXa)	25 Years	For exclusive use with ASTM F1960 fittings.
Apollo® PEX Tools Expansion (PEXa) and Crimp (PEXb)	5 Years	From date of purchase and when used in accordance with instructions.
Apollo® Copper Push	Lifetime	Must be installed per published installation instructions.
Apollo® Valves	5 Years	Must be installed per published installation instructions.
Blue Twisters®	5 Years	Must be installed per published installation instructions.
Sprint and Flexi-Adapters	5 Years	Must be installed per published installation instructions.
Apollo® and Apollo Flow	5 Years	Must be installed per published installation instructions.

WARRANTY AND LIMITATIONS OF LIABILITY

Conbraco Industries, Inc. and Elkhart Products Corporation warrants, to its initial purchaser only, that its products which are delivered to this initial purchaser will be of the kind described in the order or price list and will be free of defects in workmanship or material. For Valve products, this warranty is for a period of FIVE years from the date of delivery to you, our initial purchaser. This warranty applies to Apollo brand product with "Made in the USA" markings only. Should any failure to conform to these warranties appear within FIVE years after the date of the initial delivery to our initial purchaser, Conbraco will, upon written notification thereof and substantiation that the goods have been stored, installed, maintained and operated in accordance with Conbraco's recommendations and standard industry practice, correct such defects by suitable repair or replacement at Conbraco's own expense. For All Fittings, (Elkhart Products Corporation) this warranty is for a period of FIFTY years from the date of delivery to you, our initial purchaser. Elkhart Products Corporation also warrants that all fittings will be free from defects in material and workmanship which will impair their usefulness provided they are used in the service for which they are recommended. Any fitting which proves to be defective will be replaced or a credit issued, but no incidental labor charges, expenses or damages will be allowed. Apollo International™ Products: Conbraco Industries, Inc. warrants its Apollo International™ products, to be of the kind described in the order or price list and will be free of defects in workmanship or material for a period of TWO years from the date of delivery to you, our initial purchaser.

THIS WARRANTY IS EXCLUSIVE AND IS IN LIEU OF ANY IMPLIED WARRANTY OF MERCHANTABILITY, FITNESS FOR A PARTICULAR PURPOSE OR OTHER WARRANTY OF QUALITY, WHETHER EXPRESSED OR IMPLIED, EXCEPT THE WARRANTY OF TITLE AND AGAINST PATENT INFRINGEMENT. Correction of non-conformities, in the manner and for the period of time provided above, shall constitute fulfillment of all liabilities of Conbraco Industries, Inc. and Elkhart Products Corporation to our initial purchaser, with respect to the goods, whether based on contract, negligence, strict tort or otherwise. It is the intention of Conbraco Industries, Inc. that no warranty of any kind, whether expressed or implied shall pass through our initial purchaser to any other person or corporation.

LIMITATION OF LIABILITY: Conbraco Industries, Inc. and Elkhart Products Corporation SHALL NOT UNDER ANY CIRCUMSTANCES BE LIABLE FOR SPECIAL OR CONSEQUENTIAL DAMAGES SUCH AS, BUT NOT LIMITED TO, DAMAGES OR TO LOSS OF OTHER PROPERTY OR EQUIPMENT, LOSS OF PROFITS OR REVENUE, COST OF CAPITAL, COST OF PURCHASED OR REPLACEMENT GOODS, OR CLAIMS OF CUSTOMERS OF OUR INITIAL PURCHASER. THE REMEDIES OF OUR INITIAL PURCHASER, AND ALL OTHERS, SET FORTH HEREIN, ARE EXCLUSIVE, AND THE LIABILITY OF CONBRACO WITH RESPECT TO SAME SHALL NOT, EXCEPT AS EXPRESSLY PROVIDED HEREIN, EXCEED THE PRICE OF THE GOODS UPON WHICH SUCH LIABILITY IS BASED.

*It is the end user's responsibility to confirm that items intended for use satisfy local codes and standards.

LASCO Warranty

WARRANTY AND LIMITATIONS OF LIABILITY

LASCO Fittings, Inc. products are warranted to be free from manufacturing defects in materials and workmanship. They are warranted against rot, rust, and electrolyte corrosion for a period of (3) three years (for Schedule 40 PVC and Schedule 80 PVC) and (5) five years (for Swing/Swivel Joints) from date of installation. If LASCO products prove defective due to manufacturing defects in material or workmanship during that period, the manufacturer will provide new replacement units of the same type and size. No remedy will be granted under this warranty if LASCO products are not used strictly in accordance with LASCO's directions with respect to use and storage or if the products have been modified in any way.

The manufacturer's liability under expressed or implied warranty or for any reason is limited to furnishing replacement units or granting a credit for defective units. No labor expense or consequential damages will be paid by LASCO. This warranty is in lieu of all other guaranteed and warranted, expressed or implied, including but not limited to, warranties of merchantability and fitness for purpose, except for any warranties implied by law for noncommercial consumers. Any such warranties are limited to the duration of this written warranty.

LASCO Fittings, Inc. retains membership through GCBAA, GCSAA, and IA associations.

*It is the end user's responsibility to confirm that items intended for use satisfy local codes and standards.

LEED INFORMATION

All LASCO Branded Sch 40, Sch 80, CPVC Sch 80, CPVC CTS, and DWV products are made in USA in Brownsville, TN. except white and grey unions and Ultra Fix Telescoping Repair Couplings.

There is no pre or post consumer recycled material in our fittings per ASTM. We re-use nearly 100% of our own clean rework material. But this is generally less than 5%. The wood used in our pallets meet the requirements for FSC certification. All of our wood pallets are made from regionally manufactured materials. All of our boxes used in packaging are made of 30% recycled materials and meet SFI sourcing requirements.

The products that we produce at LASCO are vital to sustainable green building systems. Our products are used in rainwater harvesting, water filtration systems, grey water systems, water treatment, radon venting, etc... These systems, using LASCO Fittings, not only conserve resources but can also help building projects achieve points in many green building systems.

Part Number Index

10076402.....52	205030RMC.....86	30536.....61	31322.....58	35580.....63
10076404.....52	205040RMC.....86	30550.....61	31392.....59	35583.....63
10076406.....52	205050RMC.....86	30556.....61	31396.....59	37409.....64
10076530.....53	205060RMC.....86	30564.....61	31400.....59	37418.....64
10076594.....52	205080RMC.....86	30570.....61	31408.....59	37427.....64
10076596.....52	205100RMC.....86	30580.....61	31412.....59	37528.....64
10155563.....38	205120RMC.....86	30622.....60	31416.....59	37537.....64
10155564.....38	207013RMC.....86	30624.....60	31420.....59	37545.....64
10155565.....38	207020RMC.....86	30626.....60	31424.....59	37742.....64
10155566.....38	207030RMC.....86	30628.....60	31676.....59	37934.....65
10155567.....38	207040RMC.....86	30630.....60	31684.....59	37937.....65
10155568.....38	207050RMC.....86	30632.....60	31980.....61	401005CPRMC.....79
10155569.....38	207060RMC.....86	30634.....60	32044.....61	401005RMC.....79
10155570.....38	207080RMC.....86	30636.....60	32064.....61	401007CPRMC.....75
10170700.....49	207100RMC.....86	30638.....60	32072.....61	401007RMC.....79
10170705.....49	207120RMC.....86	30666.....55	32076.....61	401010CPRMC.....75
10170715.....49	210015RMC.....86	30688.....56	32084.....61	401010RMC.....79
10170730.....49	210020RMC.....86	30696.....56	32092.....61	401012RMC.....79
10170735.....49	210030RMC.....86	30698.....56	32530.....61	401015RMC.....79
10170745.....49	210040RMC.....86	30716.....56	32606.....59	401020RMC.....79
10170750.....49	210050RMC.....86	30734.....56	32640.....59	401074RMC.....79
10170760.....49	210060RMC.....86	30738.....56	32668.....59	401101RMC.....79
10170765.....49	210080RMC.....86	30748.....56	32700.....59	401102RMC.....75
10170790.....49	210100RMC.....86	30752.....56	32704.....60	401130RMC.....79
10170795.....49	210120RMC.....86	30756.....56	32708.....60	401131RMC.....79
10170820.....50	212016RMC.....86	30766.....56	32768.....60	401166RMC.....79
10170825.....50	212020RMC.....86	30768.....56	32770.....60	401167RMC.....79
10170835.....50	212030RMC.....86	30772.....56	32774.....60	401168RMC.....79
10170840.....50	212040RMC.....86	30776.....56	32790.....60	401209RMC.....79
10170845.....50	212050RMC.....86	30784.....56	32794.....60	401210RMC.....79
10170855.....50	212060RMC.....86	30896.....55	32818.....60	401211RMC.....79
10170860.....50	212080RMC.....86	30898.....55	32824.....60	401247RMC.....79
10170870.....50	212100RMC.....86	30900.....55	32828.....60	401248RMC.....79
10170885.....50	212120RMC.....86	30902.....55	32836.....60	401249RMC.....79
10170890.....50	215030BC.....86	30904.....55	32838.....60	401251RMC.....79
10176002.....52	220030BC.....86	30908.....55	32866.....60	402005CPRMC.....80
10176004.....52	30120.....56	30910.....55	32872.....60	402005RMC.....80
10176006.....52	30124.....57	30914.....55	32874.....60	402007RMC.....80
10176016.....52	30130.....56	30916.....55	32876.....60	402010RMC.....80
10176018.....52	30134.....57	30952.....55	32882.....56	402012RMC.....80
10176020.....52	30136.....57	30956.....55	32910.....60	402015RMC.....80
10176030.....52	30138.....57	30960.....55	32970.....59	402020RMC.....80
10176092.....53	30150.....56	30962.....55	33578.....55	402101CPRMC.....80
10176094.....53	30154.....57	30964.....55	33580.....55	402101RMC.....80
10176096.....53	30156.....57	30966.....55	33582.....55	402130RMC.....80
10176130.....53	30160.....56	31090.....58	33584.....55	402131RMC.....80
10176132.....53	30166.....57	31096.....58	33585.....55	402166RMC.....80
10176134.....53	30170.....56	31106.....58	33586.....55	402167RMC.....80
10176170.....53	30180.....56	31120.....58	33587.....55	402209RMC.....80
10176172.....53	30190.....56	31128.....58	34446.....65	402210RMC.....80
10176184.....53	30236.....56	31134.....58	34766.....63	402211RMC.....80
10176194.....52	30242.....56	31140.....58	34767.....63	402247RMC.....80
10176196.....52	30280.....57	31194.....58	34768.....63	402248RMC.....80
10176198.....52	30290.....57	31202.....58	35306.....63	402249RMC.....80
10176216.....52	30300.....57	31206.....58	35312.....63	403007RMC.....80
10176218.....52	30304.....57	31212.....58	35317.....63	405005RMC.....80
10176228.....52	30310.....57	31216.....58	35365.....63	405007RMC.....80
10176240.....52	30316.....57	31220.....58	35370.....63	405010RMC.....80
10176242.....52	30318.....57	31260.....58	35376.....63	405015RMC.....80
10176244.....52	30330.....57	31262.....58	35424.....64	406005CPRMC.....71
10176254.....52	30336.....57	31266.....58	35426.....64	406005LW.....71
10176300.....53	30338.....57	31272.....58	35440.....63	406005RMC.....71
10176302.....53	30342.....57	31280.....58	35445.....63	406007CPRMC.....71
10176320.....53	30348.....57	31288.....58	35447.....63	406007LW.....71
10188852.....38	30354.....57	31290.....59	35458.....64	406007RMC.....71
10188857.....38	30368.....57	31296.....58	35459.....64	406010CPRMC.....71
205011RMC.....86	30378.....57	31298.....59	35464.....64	406010LW.....71
205020RMC.....86	30436.....53	31306.....58	35466.....64	406010RMC.....71
205025RMC.....86	30444.....57	31314.....58	35578.....63	406012RMC.....71

Part Number Index

406015RMC.....71	4135007GRMC.....69	436020RMC.....77	449007RMC.....79	69TANKKIT.....39
406020RMC.....71	4135010GRMC.....69	436074RMC.....77	449010RMC.....79	69TANKMAX.....39
406101RMC.....71	4136005RMC.....69	436101RMC.....77	449012RMC.....79	69TANKPRO.....39
406130RMC.....71	4136007RMC.....69	436102RMC.....77	449015RMC.....79	69TANKTEE.....39
406131RMC.....71	4136010RMC.....69	436131RMC.....77	449020RMC.....79	77WLF10301.....53
406167RMC.....71	4136074RMC.....69	436132RMC.....77	450005RMC.....77	77WLF10401.....53
406168RMC.....71	4137101RMC.....68	436168RMC.....77	450007RMC.....77	77WLF10501.....53
407005CPRMC.....72	4137130RMC.....68	436169RMC.....77	450010RMC.....77	801005RMC.....83
407005RMC.....72	4137131RMC.....68	436212RMC.....77	450012RMC.....77	801007RMC.....83
407007RMC.....72	4140007RMC.....68	436213RMC.....77	450015RMC.....77	801010RMC.....83
407010RMC.....72	414005RMC.....78	436251RMC.....77	450020RMC.....77	801012RMC.....83
407012RMC.....72	414101RMC.....78	437101RMC.....73	457005RMC.....81	801101RMC.....83
407015RMC.....72	414130RMC.....78	437130RMC.....73	457007RMC.....81	802005RMC.....83
407020RMC.....72	4147005RMC.....68	437131RMC.....73	457010RMC.....81	802007RMC.....83
407074RMC.....72	4147007RMC.....68	437166RMC.....73	457012RMC.....81	805005RMC.....83
407101CPRMC.....72	4147010RMC.....71	437167RMC.....73	457015RMC.....81	805007RMC.....83
407101RMC.....72	417005CPRMC.....71	437168RMC.....73	457020RMC.....81	805010RMC.....83
407130RMC.....72	417005RMC.....71	437209RMC.....73	458005RMC.....81	805012RMC.....83
407131RMC.....72	417007CPRMC.....71	437210RMC.....73	458007RMC.....81	806005RMC.....79
408005RMC.....72	417007RMC.....71	437211RMC.....73	458010RMC.....81	806007RMC.....79
408007RMC.....72	417010CPRMC.....71	437212RMC.....73	458012RMC.....81	806010RMC.....79
409005RMC.....72	417010RMC.....71	437247RMC.....73	458015RMC.....81	806012RMC.....79
409007RMC.....72	417012RMC.....71	437248RMC.....73	458020RMC.....81	807005RMC.....79
409010RMC.....72	417015RMC.....71	437249RMC.....73	46002.....62	807007RMC.....79
409012RMC.....72	417020RMC.....71	437250RMC.....73	46004.....62	807010RMC.....79
409015RMC.....72	420005RMC.....76	437251RMC.....73	46040.....62	808005RMC.....79
409020RMC.....72	420007RMC.....76	438072BC.....74	46230.....62	808007RMC.....79
410005RMC.....73	420010RMC.....76	438098BC.....74	46232.....62	808010RMC.....79
410007RMC.....73	420012RMC.....76	438101RMC.....74	46236.....62	808012RMC.....79
410010RMC.....73	420015RMC.....76	438130RMC.....74	46354.....62	817005RMC.....79
410015RMC.....73	420020RMC.....76	438131RMC.....74	46356.....62	817007RMC.....79
410020RMC.....73	42046.....65	438166RMC.....74	464007RMC.....81	817010RMC.....79
4101005CPRMC.....69	42062.....65	438167RMC.....74	464101RMC.....81	819005RMC.....79
4101005RMC.....69	429005CPRMC.....75	438168RMC.....74	46412.....62	819007RMC.....79
4101007CPRMC.....69	429005LW.....75	438209RMC.....74	464130RMC.....81	829005RMC.....81
4101007RMC.....69	429005RMC.....75	438210RMC.....74	464131RMC.....81	829007RMC.....81
4101010RMC.....69	429007CPRMC.....75	438211RMC.....74	46416.....62	829010RMC.....81
410101RMC.....73	429007LW.....75	438212RMC.....74	46560.....62	829012RMC.....81
4101094RMC.....69	429007RMC.....75	438247RMC.....74	46562.....62	830005RMC.....81
4101095RMC.....69	429010CPRMC.....75	438248RMC.....74	46570.....62	830007RMC.....81
4101101RMC.....69	429010LW.....75	438249RMC.....74	474007RMC.....73	830010RMC.....81
4101131RMC.....69	429010RMC.....75	438250RMC.....74	474010RMC.....73	830012RMC.....81
4106005CPRMC.....67	429012RMC.....75	438251RMC.....74	474015RMC.....73	835005RMC.....81
4106005RMC.....67	429015RMC.....75	439101RMC.....74	6907912CP.....14	835007RMC.....81
4106007CPRMC.....67	429020RMC.....75	439130RMC.....74	6907920CP.....14	835010RMC.....81
4106007RMC.....67	430005RMC.....76	439131RMC.....74	6907924CP.....14	835012RMC.....81
4106010RMC.....67	430007RMC.....76	439166RMC.....74	6907928CP.....14	836005RMC.....81
4106101RMC.....67	430010RMC.....76	439167RMC.....74	6907932CP.....14	836007RMC.....81
4109005RMC.....67	434005RMC.....76	439168RMC.....74	6907936CP.....14	836010RMC.....81
4109007RMC.....67	434008RMC.....76	439210RMC.....74	6907984CP.....14	836012RMC.....81
4117005RMC.....67	435005CPRMC.....76	439211RMC.....74	69PC01RB.....20	837101RMC.....80
4117007RMC.....67	435005RMC.....76	439212RMC.....74	69PC02PZ.....20	837130RMC.....80
412005RMC.....72	435007CPRMC.....76	439251RMC.....74	69PC03PZ.....20	837131RMC.....80
412007RMC.....72	435007RMC.....76	447005CPRMC.....75	69PC06PZ.....21	837168RMC.....80
412010RMC.....72	435010RMC.....76	447005RMC.....75	69PC06PZRB.....21	838101RMC.....80
4127005RMC.....67	435012RMC.....76	447007CPRMC.....75	69PC07PZ.....21	838130RMC.....80
4127007RMC.....67	435015RMC.....76	447007RMC.....75	69PFRT.....47	838131RMC.....80
4127010RMC.....67	435020RMC.....76	447010CPRMC.....75	69PFT.....20, 53	838167RMC.....80
4129005CPRMC.....68	435101RMC.....76	447010RMC.....75	69PTBJ0010C.....19	838168RMC.....80
4129005RMC.....68	435102RMC.....76	447012RMC.....75	69PTKANG143.....19	839072RMC.....80
4129007CPRMC.....68	435131RMC.....76	447015RMC.....75	69PTKC001.....20	839073RMC.....80
4129007RMC.....68	436005CPRMC.....77	447020RMC.....75	69PTKD0009.....20	839098RMC.....80
4129010RMC.....68	436005RMC.....77	448005RMC.....75	69PTKG1096.....19	839099RMC.....80
4129101RMC.....68	436007CPRMC.....77	448007RMC.....75	69PTKH00143.....19	839101RMC.....80
4129131RMC.....69	436007RMC.....77	448010RMC.....75	69PTKH00144.....19	839130RMC.....80
413005RMC.....78	436010CPRMC.....77	448012RMC.....75	69PTKH0014C.....19	839131RMC.....80
413007RMC.....78	436010RMC.....77	448015RMC.....75	69PTKH0014SS.....19	839166RMC.....80
413010RMC.....78	436012RMC.....77	448020RMC.....75	69PTKH0015K.....19	839167RMC.....80
4135005GRMC.....69	436015RMC.....77	449005RMC.....79	69PTKPCRR.....20	839168RMC.....80

Part Number Index

847005RMC.....80	ABTT112.....98	APPR30034.....23	APXE121210PK.....4	APXT11.....7
847007RMC.....80	ABTT114.....98	APPR3410.....23	APXE1234.....4	APXT1112.....7
847010RMC.....80	ABTT12.....98	APPR50012.....23	APXE1250PK.....4	APXT1134.....7
847012RMC.....80	ABTT34.....98	APPR50034.....23	APXE3434.....4	APXT12.....8
848005RMC.....81	ACPC12.....44	APPR512.....23	APXE3410PK.....4	APXT1210PK.....7
848007RMC.....81	ACPC34.....44	APPR534.....23	APXE3450PK.....4	APXT121234.....7
848010RMC.....81	ACPC3412.....44	APPW1001.....24	APXFA11.....5	APXT1250PK.....7
848012RMC.....81	ACPCAP12.....44	APPW10012.....24	APXFA1212.....5	APXT34.....7
850005RMC.....83	ACPCAP34.....44	APPW10034.....24	APXFA12125PK.....5	APXT341212.....7
850007RMC.....83	ACPDEE12.....44	APPW101.....24	APXFA1234.....5	APXT341234.....7
850010RMC.....83	ACPE12.....44	APPW1012.....24	APXFA3412.....5	APXT343412.....7
850012RMC.....83	ACPE34.....44	APPW1034.....24	APXFA3434.....5	APXT3434125PK.....7
852005RMC.....79	ACPF12.....44	APPW1038.....24	APXFA34B1F.....5, 14	APXT3450PK.....7
852007RMC.....79	ACPF1234.....44	APPW14RISER.....8	APXFAE1212.....5	APXT3410PK.....7
852010RMC.....79	ACPF34.....44	APPW201.....24	APXFB1212S.....5	APXT38.....7
852012RMC.....79	ACPM12.....44	APPW2012.....24	APXFF1212S.....9, 14	APXV11.....9
ABTC1.....97	ACPM1234.....44	APPW2034.....24	APXFF3434S.....6	APXV1212.....9
ABTC1114.....97	ACPM34.....44	APPW212.....24	APXFS1212.....6	APXV3434.....9
ABTC112.....97	ACPT12.....44	APPW234.....24	APXFS3434.....6	APXVA1238C.....9
ABTC114.....97	ACPT34.....44	APPW2512.....24	APXFSA11.....6	APXVS1238C.....9
ABTC12.....97	ACPT343412.....44	APPW2534.....24	APXGHV1234.....9	BHPWMAV.....37
ABTC125PK.....97	AF45E2PK.....37	APPW3001.....24	APXHAMTEE.....8	BHPWMSV.....37
ABTC134.....97	AF90E2PK.....37	APPW30012.....24	APXJH1210PK.....17	DE4106005RMC.....63
ABTC15PK.....97	AFDOSCOMP.....36	APPW30034.....24	APXJH3410PK.....17	DE4107005RMC.....64
ABTC34.....97	AFDWD6.....36	APPW50012.....24	APXMA11.....6	EPPB1001.....34
ABTC3412.....97	AFDWE38C34.....36	APPW50034.....24	APXMA1212.....6	EPPB10012.....34
ABTC345PK.....97	AFDWF5.....36	APPW5025.....24	APXMA125PK.....6	EPPB10034.....34
ABTE1.....97	AFIM5.....36	APPW5034.....24	APXMA1234.....6	EPPB3001.....34
ABTE112.....97	AFPF122PK.....37	APPW51.....24	APXMA125PK.....6	EPPB30012.....34
ABTE114.....97	AFQCSTOP.....36	APPW512.....24	APXMA1250PK.....6	EPPB30034.....34
ABTE12.....97	AFWMD6.....37	APPW514.....24	APXMA134.....6	EPPR1001.....34
ABTE34.....97	AFWMF6.....37	APPW534.....24	APXMA341.....6	EPPR10012.....34
ABTFA1.....97	AFWS1.....39	APPW538.....24	APXMA3412.....6	EPPR10034.....34
ABTFA112.....97	AFWS34.....39	APXBC1212.....4	APXMA3434.....6	EPPR3001.....34
ABTFA114.....97	APPB1001.....23	APXBC12125PK.....4	APXMA34345PK.....6	EPPR30012.....34
ABTFA12.....97	APPB10012.....23	APXBC3434.....4	APXMA3450PK.....6	EPPR30034.....34
ABTFA34.....97	APPB10034.....23	APXC11.....4	APXMA3812.....6	EPPW1001.....34
ABTFA12.....97	APPB101.....23	APXC1212.....4	APXMA3812.....6	EPPW10012.....34
ABTFA12.....97	APPB1210.....23	APXC121210PK.....4	APXMA3812.....6	EPPW10034.....34
ABTFA12.....97	APPB2012.....23	APXC1234.....4	APXMA3812.....6	EPPW10034.....34
ABTFA1234.....97	APPB2034.....23	APXC1238.....4	APXMA3812.....6	EPPW3001.....34
ABTFA134.....97	APPB212.....23	APXC1250PK.....4	APXMA3812.....6	EPPW30012.....34
ABTFA34.....97	APPB234.....23	APXC341.....4	APXMA3812.....6	EPPW30012.....34
ABTFA112.....98	APPB30012.....23	APXC3434.....4	APXMA3812.....6	EPPW30034.....34
ABTFA1134.....98	APPB30034.....23	APXC3410PK.....4	APXMA3812.....6	EPPW51.....34
ABTFA12.....98	APPB3410.....23	APXC3450PK.....4	APXMA3812.....6	EPPW512.....34
ABTFA34.....98	APPB50012.....23	APXC3838.....4	APXMA3812.....6	EPX534.....34
ABTFA3412.....98	APPB50034.....23	APXCM4PTO.....14	APXMA3812.....6	EPXBC125PK.....28
ABTFA345PK.....98	APPB512.....23	APXCM6PTO.....14	APXMA3812.....6	EPXBC345PK.....28
ABTMA1.....98	APPB534.....23	APXCPVC12.....4	APXMA3812.....6	EPXC11.....28
ABTMA112.....98	APPOB100012.....26	APXCPVC34.....4	APXMA3812.....6	EPXC1210PK.....28
ABTMA114.....98	APPOB10012.....26	APXCR1210PK.....16	APXMA3812.....6	EPXC12345PK.....28
ABTMA12.....98	APPOB10034.....26	APXCR1210PK.....16	APXMA3812.....6	EPXC341.....28
ABTMA1234.....98	APPOB10038.....26	APXCR1225PK.....16	APXMA3812.....6	EPXC3410PK.....28
ABTMA125PK.....98	APPOB1034.....26	APXCR125PK.....16	APXMA3812.....6	EPXC3410PK.....28
ABTMA134.....98	APPOB30012.....26	APXCR1250PK.....16	APXMA3812.....6	EPXCSST18.....32
ABTMA15PK.....98	APPOB30034.....26	APXCR12LT.....16	APXMA3812.....6	EPXDEE12.....28
ABTMA34.....98	APPOB30038.....26	APXCR15PK.....16	APXMA3812.....6	EPXDEE34.....28
ABTMA341.....98	APPOB50012.....26	APXCR3410PK.....16	APXMA3812.....6	EPXDEE3412.....28
ABTMA3412.....98	APPOB50034.....26	APXCR3410PK.....16	APXMA3812.....6	EPXE11.....28
ABTMA345PK.....98	APPR1001.....23	APXCR3425PK.....16	APXMA3812.....6	EPXE1210PK.....28
ABTME1.....97	APPR10012.....23	APXCR34LT.....16	APXMA3812.....6	EPXE1234.....28
ABTME12.....97	APPR10034.....23	APXCR3810PK.....16	APXMA3812.....6	EPXE3410PK.....28
ABTME34.....97	APPR1210.....23	APXCSST18.....8	APXMA3812.....6	EPXFA1.....29
ABTP1.....98	APPR2012.....23	APXDEE12.....5	APXMA3812.....6	EPXFA1210PK.....29
ABTP112.....98	APPR2034.....23	APXDEE34.....5	APXMA3812.....6	EPXFA12345PK.....29
ABTP114.....98	APPR212.....23	APXDEE3412.....5	APXMA3812.....6	EPXFA12S.....29
ABTP12.....98	APPR234.....23	APXE11.....4	APXMA3812.....6	EPXFA12S.....29
ABTP34.....98	APPR30012.....23	APXE12.....4	APXMA3812.....6	EPXFA341.....29
ABTT1.....98			APXMA3812.....6	EPXFA3410PK.....29
			APXMA3812.....6	EPXFA34125PK.....29
			APXMA3812.....6	EPXFA34S.....29
			APXMA3812.....6	EPXFE12S.....28

Part Number Index

EPXFS1210PK.....29	FSBBS34F18.....45	FSBIPSDC3PK.....47	L1406010RMC.....85	PLTL82.....20
EPXFS1234.....29	FSBBS34F18BV.....45	FSBIP SMA2.....43	L1406012RMC.....85	PLTL83.....20
EPXFS341.....29	FSBBS34F24.....45	FSBIP SMA34.....43	L1406015RMC.....85	PROTC118.....21
EPXFS345PK.....29	FSBBS34P18.....45	FSBMA1.....42	L1406020RMC.....85	PROTC2.....21
EPXFSA11.....29	FSBBS34P1F24.....45	FSBMA12.....42	L1407005RMC.....86	PXBEND12.....17
EPXHEAD1.....32	FSBBV1.....44	FSBMA1234.....42	L1407007RMC.....86	PXBEND34.....17
EPXHEAD12.....32	FSBBV12.....44	FSBMA134.....42	L1407010RMC.....86	PXCM3PT.....14
EPXHEAD34.....32	FSBBV12DE.....44	FSBMA1412.....42	L1407012RMC.....86	PXPA2PTC.....14
EPXM2PTO.....32	FSBBV12F.....44	FSBMA34.....42	L1407101RMC.....86	PXPA2PTO.....14
EPXM3PTO.....32	FSBBV12SL.....44	FSBMA3412.....42	L1407130RMC.....86	PXPA4PTC.....14
EPXM4PT.....32	FSBBV34.....44	FSBMA3812.....42	L1407131RMC.....86	PXPA4PTO.....14
EPXM4PTO.....32	FSBBV34DE.....44	FSBME12.....42	L1413005RMC.....85	PXPA6PTO.....14
EPXM6PT.....32	FSBBV34F.....44	FSBME1238.....42	L1413007RMC.....85	PXPAC115PK.....11
EPXMA11.....29	FSBBV34SL.....44	FSBME1438.....42	L1413010RMC.....85	PXPAC125PK.....11
EPXMA1210PK.....29	FSBC1.....41	FSBPBC12.....41	L1413012RMC.....85	PXPAC345PK.....11
EPXMA1234.....29	FSBC12.....41	FSBPBC34.....41	L1429005RMC.....85	PXPAC3415PK.....11
EPXMA134.....29	FSBC1238.....41	FSBPRV34.....45	L1429007CPRMC.....85	PXPAC34125PK.....11
EPXMA341.....29	FSBC124PK.....41	FSBPRV34SL.....45	L1429007RMC.....85	PXPAE115PK.....11
EPXMA3410PK.....29	FSBC12SL.....41	FSBSTUB8.....46	L1429010CPRMC.....85	PXPAE125PK.....11
EPXMA3412.....29	FSBC134.....41	FSBT1.....43	L1429010RMC.....85	PXPAE12345PK.....11
EPXME125PK.....28	FSBC14.....41	FSBT1134.....43	L1429012RMC.....85	PXPAE345PK.....11
EPXMS1210PK.....29	FSBC15L.....41	FSBT12.....43	L1429015RMC.....85	PXPAF1212S5PK.....11
EPXMS1234.....29	FSBC34.....41	FSBT121238.....43	L1429020RMC.....85	PXPAFES125PK.....11
EPXMS341.....29	FSBC3412.....41	FSBT12SL.....43	L1429101RMC.....85	PXPAM125PK.....12
EPXMS3410PK.....29	FSBC34SL.....41	FSBT12SLCTS.....43	L1429130RMC.....85	PXPAM345PK.....12
EPXMSA115PK.....29	FSBC38.....41	FSBT12SLF.....43	L1429131RMC.....85	PXPAM34125PK.....12
EPXPAC1110PK.....31	FSBCAP1.....44	FSBT14.....43	L1429167RMC.....85	PXPAME125PK.....11
EPXPAC1210PK.....31	FSBCAP12.....44	FSBT34.....43	L1429168RMC.....85	PXPAP125PK.....12
EPXPAC3410PK.....31	FSBCAP124PK.....44	FSBT341212.....43	L1429212RMC.....85	PXPAP345PK.....12
EPXPAE1210PK.....31	FSBCAP12WD.....44	FSBT341234.....43	L1429251RMC.....85	PXPAT125PK.....12
EPXPAE15PK.....31	FSBCAP34.....44	FSBT343412.....43	L1435005RMC.....86	PXPAT1212345PK.....12
EPXPAE3410PK.....31	FSBCAP34WD.....44	FSBT34F.....43	L1435007RMC.....86	PXPAT345PK.....12
EPXPAM1210PK.....31	FSBCAP38.....44	FSBT34SL.....43	L1435010RMC.....86	PXPAT3412125PK.....12
EPXPAP110PK.....31	FSBCSST34F18.....45	FSBT34SLF.....43	L1435012RMC.....86	PXPAT3412345PK.....12
EPXPAP1210PK.....31	FSBCSST34F24.....45	FSBT38.....43	L1436005RMC.....86	PXPAT3434125PK.....12
EPXPAP3410PK.....31	FSBCV12.....45	FSBT141438C.....46	L1436007RMC.....86	PXC110PK.....16
EPXPAT1210PK.....31	FSBCV34.....45	FSBTANKTEE.....43	L1436010RMC.....86	PXPC1210PK.....16
EPXPAT15PK.....31	FSBDC1.....47	FSBTWG34.....46	L1436012RMC.....86	PXPC1210QJR.....16
EPXPAT3410PK.....31	FSBDC12.....47	FSBVA1212M.....44	L1436015RMC.....86	PXPC12100PK.....16
EPXS1225PK.....32	FSBDC14.....47	FSBVA1214.....44	L1436020RMC.....86	PXPC1225PK.....16
EPXS125PK.....32	FSBDC34.....47	FSBVA1214C.....44	L1436074RMC.....86	PXPC15PK.....16
EPXS3425PK.....32	FSBDC38.....47	FSBVA1238C.....44	L1436101RMC.....86	PXPC3410PK.....16
EPXSCV1234.....30	FSBDEE12.....42	FSBVA1212M.....44	L1436102RMC.....86	PXPC34100JR.....16
EPXSTUBWE12.....32	FSBDEE12P.....42	FSBVS1212M.....44	L1436131RMC.....86	PXPC34100PK.....16
EPXSTUBWE34.....32	FSBDEE3812.....42	FSBVS1214C.....44	L1436167RMC.....86	PXPC3425PK.....16
EPXT11.....30	FSBDG.....47	FSBVS1238C.....44	L1436168RMC.....86	PXPC3810PK.....16
EPXT1112.....30	FSBDT12.....47	FSBVT121214C.....44	L1436169RMC.....86	PXSS1210PK.....16
EPXT1134.....30	FSBDT34.....47	FSBVT121238C.....44	L1436212RMC.....86	PXSS1225PK.....16
EPXT1210PK.....30	FSBDWE1434.....42	FSBVT343414C.....44	L1449005RMC.....87	PXSS3410PK.....16
EPXT121234.....30	FSBE1.....41	FSBWHKIT.....45	L1449007RMC.....87	PXSS3425PK.....16
EPXT341212.....30	FSBE12.....41	FSBWMAV.....45	L1449010RMC.....87	SPRC34.....95
EPXT341234.....30	FSBE124PK.....41	FSBWMSV.....45	LPC01005RMC.....89	SPRCAP34.....95
EPXT3434125PK.....30	FSBE34.....41	L1401005RMC.....87	LPC01007RMC.....89	SPRE34.....95
EPXT345PK.....30	FSBE3412.....41	L1401007RMC.....87	LPC01010RMC.....89	SPRFLX12341.....95
EPXTTOOL.....32	FSBE38.....41	L1401010RMC.....87	LPC06005RMC.....89	SPRFLX123434.....95
EPXTTOOLKIT.....32	FSBFA1.....42	L1401012RMC.....87	LPC06007RMC.....89	SPRMA34.....95
EPXV1.....30	FSBFA12.....42	L1401015RMC.....87	LPC06010RMC.....89	SPRT34.....95
EPXV12.....30	FSBFA1234.....42	L1401020RMC.....87	LPC29005RMC.....89	WHBS34F12.....38
EPXV34.....30	FSBFA124PK.....42	L1401101RMC.....87	LPC29007RMC.....89	WHBS34F18.....38
EPXVA1214C.....30	FSBFA1412.....42	L1402005RMC.....87	LPC29010RMC.....89	WHBS34F24.....38
EPXVA1238C.....30	FSBFA34.....42	L1402007RMC.....87	LPC2918005RMC.....89	WHBS34F7818.....38
EPXVS1214C.....30	FSBFA3812.....42	L1402010RMC.....87	LPC2918007RMC.....89	WHC34F24.....38
EPXVS1238C.....30	FSBFAU14.....46	L1402011RMC.....87	LPC2918010RMC.....89	WHC34F34S18.....38
FSBBOXIM.....46	FSBFAU1412.....46	L1402130RMC.....87	LPC47005RMC.....89	WHCOMP12C34M.....38
FSBBOXIMWH.....46	FSBFAU1438.....46	L1402131RMC.....87	LPC47007RMC.....89	WHCOMP34.....38
FSBBOXWM.....46	FSBFAU1478.....46	L1402166RMC.....87	LPC47010RMC.....89	WHCSST1F18.....38
FSBBOXWMWH.....46	FSBFE12.....42	L1402167RMC.....87	LPRT005RMC.....89	WHCSST34F24.....38
FSBBS12P18.....45	FSBIPSC1.....41	L1402168RMC.....87	LPRT007RMC.....89	WHCSST34P1F24.....38
FSBBS34F12.....45	FSBIPSC12.....41	L1406005RMC.....85	LPRT010RMC.....89	
FSBBS34F15.....45	FSBIPSC34.....41	L1406007RMC.....85	PLTL60.....20	

